



## ExMax ¼ turn actuators – size S

Electrical, explosion proof rotary actuators

On-off / 3-pos. control mode, 24...240 VAC/DC, 95° angle of rotation incl. 5° pretension

5/10 Nm, 15/30 Nm without and 5/10 Nm, 15 Nm with safety operation (spring return)

ATEX tested in acc. with directive 94/9/EC for zone 1, 2, 21, 22

ExMax - ...
ExMax - ... - F
ExMax - ... - S
ExMax - ... - SF
ExMax - ... - CTS
ExMax - ... - VAS

Subject to change!

## Compact. Easy installation. Universal. Cost effective. Safe.

Type	Torque	Supply	Motor running time	Spring return	Control mode	Feedback	Wiring diagram
ExMax- 5.10	5 / 10 Nm	24...240 VAC/DC	3 / 15 / 30 / 60 / 120 s/90°	–	On-off, 3-pos.	–	SB 1.0
ExMax-15.30	15 / 30 Nm	24...240 VAC/DC	3 / 15 / 30 / 60 / 120 s/90°	–	On-off, 3-pos.	–	SB 1.0
ExMax- 5.10 - F	5 / 10 Nm	24...240 VAC/DC	3 / 15 / 30 / 60 / 120 s/90°	3 or 10 s/90°	On-off, 3-pos.	–	SB 2.0 + 2.1
ExMax- 15 - F	15 Nm	24...240 VAC/DC	3 / 15 / 30 / 60 / 120 s/90°	3 or 10 s/90°	On-off, 3-pos.	–	SB 2.0 + 2.1
ExMax- ... - S/SF	Types as above with 2 integral, potential free auxiliary switches, 5° and 85° angle of rotation					2 × limit switches	SB 3.0
ExMax- ... - CTS	Types as above with aluminium housing and seawater resistant C5-M painting (cable glands brass nickel-plated)						
ExMax- ... - VAS	Types as above with stainless steel housing for aggressive ambient (cable glands brass nickel-plated)						

### Product views and applications

Safety damper



Ball valve

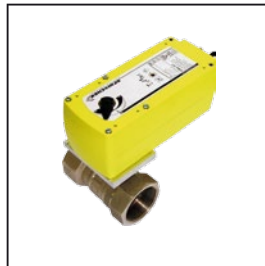

Throttle valve



### Description

The ExMax actuators are a revolution for safety, control and shut-off dampers, VAV systems, ball valves, throttle valves and other motorized applications for HVAC systems in chemical, pharmaceutical, industrial and offshore/onshore plants, for use in Ex-areas zone 1, 2 (gas) and zone 21, 22 (dust).

Highest protection class (ATEX) and IP66 protection, small dimensions, only 3,5 kg weight, universal functions and technical data, an integrated heater and an optional stainless steel housing guarantee safe operation even under difficult environmental conditions. High quality brushless motors guarantee long life.

All actuators are programmable and adjustable on site. Special tools or equipment are not required. Motor running times and torques as well as spring return times, according to the actuator type, are selectable or adjustable on site. The integrated universal power supply is self adaptable to input voltages in the range of 24...240 VAC/DC. The actuators are 100 % overload protected and self locking.

...Max-...F actuators are equipped with spring return fail safe function. Standard shaft connection is a double square direct coupling with 12 × 12 mm.

Different accessories are available to adapt auxiliary switches, terminal boxes or adaptations for ball valves and throttle valves and other armatures.

### Highlights

- ▶ For all type of gas, mixtures, vapours and dust for use in zone 1, 2, 21 and 22
- ▶ Universal supply unit from 24...240 VAC/DC
- ▶ 5 different motor running times 3–15–30–60–120 s/90°, adjustable on site
- ▶ 2 different spring return running times ~ 3–10 s/90°, selectable on site
- ▶ On-off and 3-pos. control with or without spring return function
- ▶ 2 integrated auxiliary switches, switching at 5° and 85° (option ...-S)
- ▶ 5–10–15–30 Nm actuators in the same housing size
- ▶ 100 % overload protected and self locking
- ▶ Compact design and small dimension (L × W × H = 210 × 95 × 80 mm)
- ▶ Direct coupling to the damper shaft with double square connection 12 × 12 mm
- ▶ 95° angle of rotation inclusive 5° pretension
- ▶ Robust aluminium housing (optional stainless steel + seawater resistant C5-M painting)
- ▶ IP66 protection
- ▶ Simple manual override included + preparation for comfortable manual override
- ▶ Gear made of stainless steel and sinter metal
- ▶ Weight only ~ 3,5 kg
- ▶ Integral heater for ambient temperatures down to -40 °C
- ▶ Integral safety temperature sensor
- ▶ Integral equipment for manual adjustment (push button, lamp, switch)
- ▶ Preparation for adaptable and adjustable auxiliary switches type ...Switch
- ▶ Wide range of accessories



ExMax-...

ExMax-...-F

ExMax-...-S

ExMax-...-SF

**SCHISCHEK**  
EXPLOSIONPROOF

Special options

... -CTS

... -VAS

Technical data	ExMax- 5.10	ExMax- 15.30	ExMax- 5.10 -F	ExMax- 15 -F
Torque motor (min.)	5 / 10 Nm selectable on site	15 / 30 Nm selectable on site	5 / 10 Nm selectable on site	15 Nm
Torque spring (F)	–	–	min. 10 Nm	min. 15 Nm
Dimension of external torque	Above mentioned torques are min. torques in blocked position, external torque should be max. 80 % of max. actuator torque but min. 3 Nm			
Supply voltage / frequency	24...240 VAC/DC, ± 10 %, self adaptable, frequency 50...60 Hz ± 20 %			
Power consumption	max. starting currents see ① Extra information (in acc. with voltage, $I_{start} \gg I_{rated}$ ), approx. 5 W holding power, approx. 16 W for heater			
Protection class	Class I (grounded)			
Angle of rotation and indication	95° incl. ~ 5° pretension, mechanical value indication			
Working direction	Selectable by left/right mounting to the damper/valve shaft			
Motor running times	3 / 15 / 30 / 60 / 120 s/90° selectable on site			
3 sec. mode – motor	In acc. with the supply voltage and external torque 3 to 4 s/90° angle of rotation			
Motor	Brushless DC motor			
Spring return (F)	–	–	spring return in the event of loss of power	
Spring return running time (F)	–	–	spring return in ~ 3 or 10 s/90°, selectable on site	
3 sec. mode – spring return	–	–	in acc. with external torque ~ 3 to 4 s/90° angle of rotation	
Safety operation at 10 sec. (F)	–	–	min. 10,000 in acc. with construction of damper and ambient	
at 3 sec. (F)	–	–	min. 1,000 in acc. with construction of damper and ambient	
Response time spring return	up to 1 sec. after power failure			
Control mode	On-off and 3-pos. in acc. with wiring, selectable on site			
Axle of the actuator	Double square 12 × 12 mm, direct coupling, 100 % overload protected and self locking up to 15 Nm			
Electrical connection	Cable ~ 1 m, wire cross section 0.5 mm <sup>2</sup> , equipotential bonding 4 mm <sup>2</sup> . Connections in hazardous areas require an Ex-e terminal box!			
Diameter of cable	~ Ø 7.1 mm	~ Ø 7.1 mm	~ Ø 7.4 mm	~ Ø 7.4 mm
Cable gland	2 cable glands in the versions ...-S and ...-SF (~ Ø ... + 7.4 mm)			
Manual override	M16 × 1.5 mm standard cable and wire entries are integral part of explosion proof encapsulation, tested acc. to EN 60079-1			
Integral heater	Use delivered socket wrench, max. 4 Nm			
Housing material	Integral, controlled heater for ambient temperature down to -40 °C			
Dimensions	Aluminium die cast housing, painted. Optional with seawater resistant C5-M finish (...-CTS) or housing in stainless steel DIN EN 1.4581 / V4A / UNS-J92900 / similar AISI 316 Cb (...-VAS)			
Weight	L × W × H = 210 × 95 × 80 mm, for diagrams see ① Extra information			
Ambients	~ 3,5 kg aluminium housing, stainless steel ~ 7 kg			
Humidity	Storage temperature -40...+70 °C, working temperature -40...+40 °C at T6 resp. -40...+50 °C at T5			
Operating 3 sec. motor run time	0...90 % rH, non condensing			
≥ 15 sec. motor run time	In 3 s mode the motor will work only after 1 minute of voltage supply. While open/close operation (open voltage supply and shut it down) motor works only with speed of 15 s/90°			
Maintenance	At 15 / 30 / 60 / 120 s 100 % of ED is permitted (ED = duty cycle)			
Wiring diagrams	Maintenance free relative to function, maintenance must comply with regional standards, rules and regulations			
Scope of delivery	SB 1.0	SB 1.0	SB 2.0 / 2.1	SB 2.0 / 2.1
Parameter at delivery	Actuator with 1 m cable, 4 screws M4 × 100 mm, 4 nuts M4, Allen key for simple manual override			
	5 Nm, 30 s/90°	15 Nm, 30 s/90°	5 Nm, 30 s/90°	15 Nm, 30 s/90°

**Approbations**

ATEX tested	PTB 04 ATEX 1028 X
IECEX tested	IECEX PTB 07.0057X
In acc. with ATEX	94/9/EC
Approval for gas	II 2 (1) G Ex d [ia] IIC T6/T5 zone 1, 2
Approval for dust	II 2 (1) D Ex tD [iaD] A21 IP66 T80/T95°C zone 21, 22
Identification	CE No. 0158
EMC	2004/108/EC
Low voltage	2006/95/EC
IP-Protection	IP66 in acc. with EN 60529

**Special solutions and accessories**

...-CTS	Types in aluminium housing with C5-M finish, parts nickel-plated
...-VAS	Types in stainless steel housing, parts nickel-plated
ExBox-...	Ex-e terminal boxes for zone 1, 2, 21, 22
MKK-S	Mounting bracket for boxes type ...Box-... directly on actuator
ExSwitch	2 external aux. switches, adjustable for zone 1, 2, 21, 22
HV-S...	Comfortable manual override for ...Max actuators size S
KB-S	Clamp for damper shafts Ø 10...20 mm and □ 10...16 mm
AR-12-xx	Reduction part for 12 mm square connection to 11, 10, 9 or 8 mm shafts
Kit-S8	Cable glands nickel-plated
Adaptions	for dampers and valves on request
ExMax-...-S3	Ambient temperature up to +60 °C (T4), 110...240 VAC/DC, 25 % ED
ExMax-...-S7	Actuator shock approved up to 500 g

ExMax-S-3P\_en  
V02 – 3-Feb-2015



ExMax-...

ExMax-...-F

ExMax-...-S

ExMax-...-SF



Special options

... -CTS

... -VAS

### Electrical connection

All actuators are equipped with a universal supply unit working at a voltage range from 24...240 VAC/DC. The supply unit is self adjusting to the connected voltage!  
 The safety operation of the spring return function works if the supply voltage is cut.  
 For electrical connection inside hazardous areas an Ex-e terminal box, certificated in acc. with ATEX is required (e.g. ExBox).  
 An over-current protection fuse < 10 A has to be provided by installer.  
 Note: the initial current is appr. 2 A for 1 second.

### Wiring diagram ExMax- ... (without spring return)

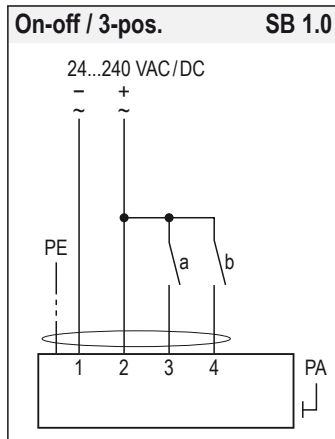

During commissioning apply a self adjustment drive.

Regard duty cycle at motor running times!

Never use spring return actuators without external load.

### Wiring diagram ExMax- ... -F (with spring return)

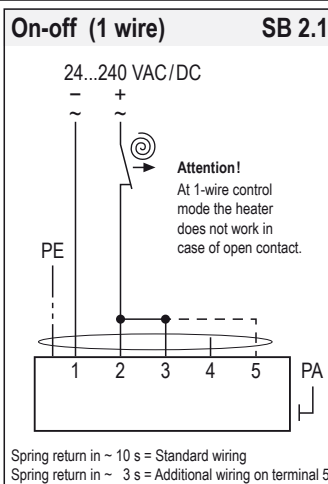
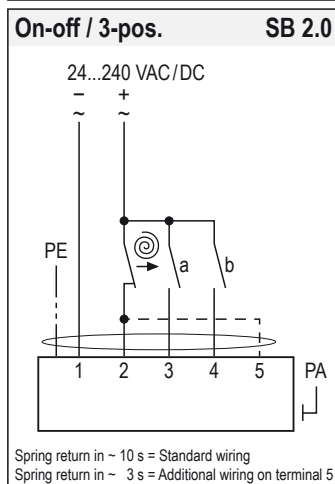

### Wiring diagram ExMax- ... -S and ... -SF

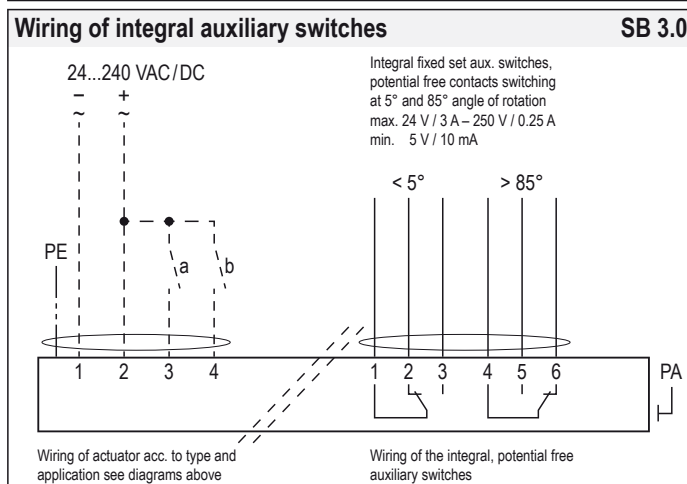

### Parameters, adjustments and failure indication

**Switch – Push button – Lamp for adjustment (behind the blanking plug)**

10-position switch (S)  
 Push button (T)  
 3-colour LED

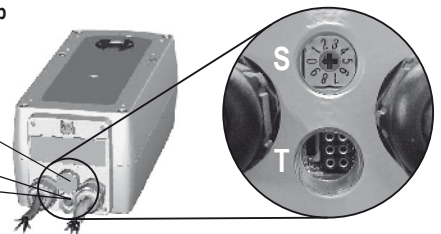

### Parameter selection

Example:  
 ExMax-15.30  
 Requested parameter:  
 Torque 30 N  
 Motor running time 30 s/90°

Type	Torques	
ExMax- 5.10	5 N	10 N
<b>ExMax- 15.30</b>	<b>15 N</b>	<b>30 N</b>
ExMax- 5.10-F	5 N	10 N
ExMax- 15-F	15 N	30 N

Running times	Position of switch (S)	
3 s/90°	00	05
15 s/90°	01	06
<b>30 s/90°</b>	<b>02</b>	<b>07</b>
60 s/90°	03	08
120 s/90°	04	09

Result:  
 Switch position **07**

### Functions, adjustments and parameters

#### A) Self adjustment of angle of rotation:

Switch (S) into position 02 (low torque) or 07 (high torque), then push button (T) for minimum 3 seconds. The actuator will drive into both end positions to be adjusted. LED indicates GREEN.

Adjustment time needs approx. 60 sec. (30 sec. "On", 30 sec. "Off"). After that switch (S) into the position acc. with your required torque and running time.

#### B) Selection of running time and torque:

Put switch (S) into the correct selected position in acc. to above table. The selected parameter will work at next operation of the actuator. Adjustment can be done even without supply voltage. If supply voltage is available turn switch only if actuator is not running.

#### C) Running time spring return:

The running time of 3 or 10 sec. spring return is selected by wiring (see wiring diagrams SB 2.0 and 2.1).

#### D) Additional information for 3-pos. operation:

a closed, b open = direction I a and b closed = motor doesn't work  
 b closed, a open = direction II a and b open = motor doesn't work  
 The rotation direction (I and II) depends on left/right mounting of the actuator to the damper/valve. You can change direction of the motor by changing electrical wiring of terminal 3 and 4.

### Installation

Ex area – zone 1, 2, 21, 22



Safe area

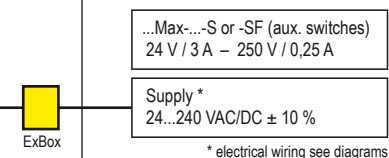

- Do not open the cover when circuits are live
- Supply cables must be installed in a fixed position and protected against mechanical damage
- Connect potential earth
- Avoid temperature transfer from process (e.g. hot gas) to actuator (note max. ambient temperature!)
- Note ambient temperature
- Close all openings with min. IP66
- Regard all (inter-)national standards, rules and regulations
- Flameproof enclosure is protected against mechanical damages acc. to EN 60079-ff
- For outdoor installation a protective housing against rain, snow and sun should be applied to the actuator, as well as a constant supply at terminal 1 and 2 for the integral heater
- Use for wiring an explosion proof Ex-e terminal box
- Actuators are maintenance free, an annual function test is recommended
- Clean only with damp cloth, avoid dust accumulation



ExMax-...

ExMax-...-F

ExMax-...-S

ExMax-...-SF

**SCHISCHEK**  
EXPLOSIONPROOF

Special options

... -CTS

... -VAS

**Important information for installation and operation****A. Installation, commissioning, maintenance**

All national and international standards, rules and regulations for hazardous Ex-areas must be complied. For electrical connection an Ex-e terminal box is requested (e.g. ExBox-...).

**Attention:** If the actuator is put out of operation all Ex rules and regulation must be applied. You have to cut the supply voltage before opening a terminal box!

The cable of the actuator must be installed in a fixed position and protected against mechanical and thermal damage. Connect potential earth. Avoid temperature transfer from armature to actuator! Close all openings with min. IP66. For outdoor installation a protective housing against sun, rain and snow should be applied to the actuator as well as a constant supply at terminal 1 and 2 for the integral heater. Actuators are maintenance free. An annual inspection is recommended. Ex-actuators must not be opened by the customer.

**B. Manual override**

Manual override only if supply voltage is cut. Use delivered socket wrench with slow motions, usage can be tight.

**Attention:** Releasing or letting go the Allen key too fast at manual operating actuators with spring return causes risk of injury!

**C. Shaft connection, selection of running time**

Actuators are equipped with a direct coupling double square shaft connection of 12 x 12 mm. For round shafts adaptors/clamping connection (accessories, e.g. KB-S) are available. The housing of the actuator is axially symmetrically built to select Open-close direction of the spring return function by left-/right-mounting. Using the 10-position switch different motor running times and spring return running times can be selected on site in acc. to the actuator type.

**D. Operation with 3 sec. motor running time**

Note following:

1. The 3 sec. motor running time mode is only available in switch position 0 and 5 and at a constant supply voltage applied for a minimum of 1 minute on terminal 1 and 2.
2. The actuator opens at voltage on terminal 3 (resp. closes) and closes at voltage on terminal 4 (resp. opens) – depending on mounting position of the actuator.
3. The max. duty ratio is 10 % resp. 1 cycle/minute. Between two fully 3 sec. cycles in the same direction there must be a minimum intermission of 1 minute. Trying to run the actuator in the same direction in less than the required minimum of 1 minute the function will be blocked for the rest of the idle period. Later the release for the next cycle is made automatically by an internal timing relay.
4. Same function is applied on spring return actuators, fail safe operation is regarded same as a motor running cycle.
5. Trying to use the 1 wire On-off methode in switch position 0 and 5, software changes the motor running time temporarily and automatically to 15 s/90° to protect the actuator for overheating due to uncontrolled duty ratio.
6. The actuator must be operated with an outside load of at least 3 Nm.
7. After installing the actuator to the damper/armature an automatic alignment has to be accomplished in order to obtain a "gentle" blockade/stop. This function protects the damper/armature by reducing the end position/blockade speed in order to avoid mechanical overload. The actuator aligns specifically once with 30 s/90° onto each end position and recognizes the blockade position in order to reduce the motor performance during operation briefly before reaching the end/blockade position.

**E. 3-position control mode**

...Max actuators are in the best way suitable for the 3-pos. operation. To protect such elements as gears and mounting elements against harmful influences like minimum pulse time, ...Max actuators are protected via internal electronics. It ignores impulses < 0.5 s, the cyclic duration must be min. 0.5 s. At changing direction the pause is 1 s.

**F. Spring return**

Spring return function works only if the supply voltage for terminal 1 or 2 is cut. In the event of an electrical interruption, the spring returns to its end position even if supply voltage is available again during return function. Thereafter operation will continue.

**G. Operation at ambient temperatures below -20 °C**

All actuators are equipped with a regulated integrated heating device designed for employments down to -40 °C ambient temperature. The heater will be supplied automatically by connecting the constant voltage supply on the clamps 1 and 2.

1. After mounting the actuator must be immediately electrically connected.
2. The heater switches on automatically when actuator reaches internally -20 °C. It heats up the actuator to a proper working temperature, then heater switches off automatically. Actuator will not run during heating process.
3. The adjustment options are only ensured after this heating up period.

**H. Excess temperatures**

In acc. to the ATEX rules and regulations Ex actuators must be protected against excess temperature. The internal thermostat works as a maximum limiter and, in the event of failure at incorrect temperatures, shuts off the actuator irreversible. An upstream connected temperature sensor stops the actuator before reaching its max. temperature. This safety feature is reversible, after cooling down the actuator is completely functional again. In this case the failure must be eliminated immediately on site!

**I. Synchron mode**

Do not connect several actuators to one shaft or link mechanically together.

**J. Mechanical protection**

The actuator must be operated with an outside load of at least 3 Nm. After installing the actuator to the damper/armature an automatic alignment has to be accomplished in order to obtain a "gentle" blockade/stop. This function protects the damper/armature by reducing the end position's/blockade speed in order to avoid mechanical overload. The actuator aligns specifically once with 30 s/90° onto each position and recognizes the blockade position in order to reduce the motor performance during operation briefly before reaching the end/blockade position.

**K. Intrinsically safe circuits**

The actuator itself has a flameproof enclosure. The supply of the push button (adjustment drive), the 10-position switch (adjustment of torque and running time) and the LED indicator is performed intrinsically safe!

**L. Loss of voltage**

In switch position 00, 01 and 05, 06 (motor running times 3 sec. and 15 sec.) and after interrupted voltage the actuator (types 5.10 and 15.30 and ...-S) moves in OFF position then the actuators works regarding control signal.

**ⓘ Extra information (see additional data sheet)**

Additional technical information, dimensions, installation instruction, illustration and failure indication

**Accessory ExSwitch – adaptable Ex-d auxiliary switch**

For an end or inclined position indication it is possible to retrofit external, adjustable, explosion proof auxiliary switches type ExSwitch. The switch housing is mounted directly to the actuator and the switches are linked to the actuator's square connector. The switches deliver a potential free output and can be adjusted separately. They are connected by the included cable tail.

**Accessory ExBox – adaptable Ex-e terminal box**

For electrical connection of ...Max actuators inside the hazardous area an Ex-e terminal box is required. ExBoxes are appropriate terminal boxes and placed at the disposal. To adapt the ...Box directly to the actuator housing a mounting bracket type MKK-S is required.

ExBox- 3P for ...Max-... and ...Max-...-F  
ExBox- Y/S for ...Max-...-S and ...-SF with integral auxiliary switches