

PRESSOSTAT

Swiss based Trafag is a leading international supplier of high quality sensors and monitoring instruments for measurement of pressure and temperature.

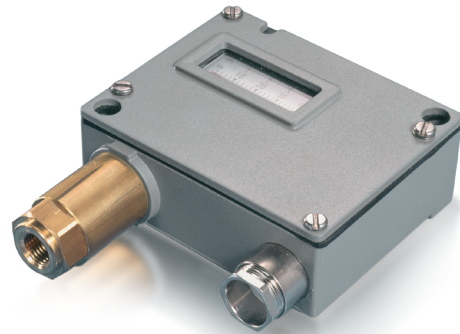

Applications

- Shipbuilding
- Engine manufacturing
- Railways
- Machine tools
- Hydraulics

Features

- Rugged aluminium housing
- Protection IP65
- Any mounting position possible

| Technical Data | | | |
|------------------------|--|---------------------|--|
| Measuring principle | Bellow | Repeatability | ± 1.0 % FS typ. |
| Measuring range | -0.9 ... 1.5 to 10 ... 100 bar 5 ... 50 to 125 ... 1500 psi | Media temperature | -40°C ... +150°C |
| Output signal | Floating change-over contact | Ambient temperature | -25°C ... +70°C |
| Switching differential | Not adjustable | Approval | ABS, BV, CCS, DNV, GL, KRS, LRS, RINA EN60730-1/ EN60730-2-6: Typ 2.B.H |

04/2015

Data sheet H72252q



Subject to change

Ordering information/type code

| | | XXX | XX | XX | XXXXXX | XX | XX |
|--------------------------|--|-----|----|----|--------|----|----|
| Custom build code | With display and adjusting screw | 900 | | | | | |
| | Without display, with adjusting screw | 904 | | | | | |
| | With display and adjusting knob | 912 | | | | | |
| Microswitch | Small switching differential, standard vibration resistance ^{1) 2)} | | | | | | 10 |
| | Average switching differential, standard vibration resistance ¹⁾ | | | | | | 11 |
| | Average switching differential, improved vibration resistance ¹⁾ | | | | | | 23 |
| | Large switching differential, high vibration resistance ¹⁾ | | | | | | 26 |
| | With gold plated contacts, standard vibration resistance ¹⁾ | | | | | | 21 |

| Range | Range [bar] | Over pressure [bar] | Burst pressure [bar] | | Range [psi] | Over pressure [psi] | Burst pressure [psi] | |
|-------------|--------------|---------------------|----------------------|----|--------------|---------------------|----------------------|-----|
| | -0.9 ... 1.5 | 10 | 13 | 72 | | 5 ... 50 | 175 | 350 |
| 0.2 ... 1.6 | 10 | 13 | 73 | | 10 ... 100 | 350 | 500 | G8 |
| 0.2 ... 2.5 | 10 | 13 | 75 | | 25 ... 200 | 350 | 500 | G9 |
| 0 ... 4 | 12 | 26 | 76 | | 50 ... 500 | 500 | 1000 | H1 |
| 0 ... 6 | 12 | 26 | 77 | | 125 ... 1500 | 1500 | 2300 | H3 |
| 1 ... 10 | 24 | 36 | 78 | | | | | |
| 1 ... 16 | 24 | 36 | 79 | | | | | |
| 2 ... 25 | 40 | 75 | 80 | | | | | |
| 4 ... 40 | 40 | 75 | 81 | | | | | |
| 6 ... 60 | 100 | 160 | 82 | | | | | |
| 10 ... 100 | 100 | 160 | 83 | | | | | |

| Sensor | Sensor material | Sensor housing material | Thread | Range | | Sensor material | Sensor housing material | Thread | Range | |
|------------------------|--------------------------------|-------------------------|--------------|--------|------------------------|--------------------------------|--------------------------------|--------------|--------|-----|
| | Bronze bellow (CuSn6) | Brass (CuZn39Pb3) | G1/4" female | 72 | 900 | Bronze bellow (CuSn6) | Brass chemically nickel plated | G1/4" female | 78, 79 | 955 |
| Bronze bellow (CuSn6) | Brass (CuZn39Pb3) | G1/4" female | 73, 75 | 901 | Bronze bellow (CuSn6) | Brass chemically nickel plated | G1/4" female | 80, 81 | 957 | |
| Bronze bellow (CuSn6) | Brass (CuZn39Pb3) | G1/4" female | 76, 77 | 903 | Bronze bellow (CuSn6) | Brass chemically nickel plated | G1/2" male | 72 | 959 | |
| Bronze bellow (CuSn6) | Brass (CuZn39Pb3) | G1/4" female | 78, 79 | 905 | Bronze bellow (CuSn6) | Brass chemically nickel plated | G1/2" male | 73, 75 | 952 | |
| Bronze bellow (CuSn6) | Brass (CuZn39Pb3) | G1/4" female | 80, 81 | 907 | Bronze bellow (CuSn6) | Brass chemically nickel plated | G1/2" male | 76, 77 | 954 | |
| Stainless steel 1.4435 | Brass (CuZn39Pb3) | G1/4" female | 82, 83 | 940 | Bronze bellow (CuSn6) | Brass chemically nickel plated | G1/2" male | 78, 79 | 956 | |
| Bronze bellow (CuSn6) | Brass (CuZn39Pb3) | G1/2" male | 72 | 909 | Bronze bellow (CuSn6) | Brass chemically nickel plated | G1/2" male | 80, 81 | 958 | |
| Bronze bellow (CuSn6) | Brass (CuZn39Pb3) | G1/2" male | 73, 75 | 902 | Stainless steel 1.4435 | Brass nickel plated | G1/4" female | 72 | 800 | |
| Bronze bellow (CuSn6) | Brass (CuZn39Pb3) | G1/2" male | 76, 77 | 904 | Stainless steel 1.4435 | Brass nickel plated | G1/4" female | 73, 75 | 801 | |
| Bronze bellow (CuSn6) | Brass (CuZn39Pb3) | G1/2" male | 78, 79 | 906 | Stainless steel 1.4435 | Brass nickel plated | G1/4" female | 76, 77 | 803 | |
| Bronze bellow (CuSn6) | Brass (CuZn39Pb3) | G1/2" male | 80, 81 | 908 | Stainless steel 1.4435 | Brass nickel plated | G1/4" female | 78, 79 | 805 | |
| Stainless steel 1.4435 | Brass | G1/2" male | 82, 83 | 941 | Stainless steel 1.4435 | Brass nickel plated | G1/4" female | 80, 81 | 807 | |
| Bronze bellows (CuSn6) | Brass (CuZn39Pb3) | 1/4"NPT female | G6 | G6.103 | Stainless steel 1.4435 | Brass nickel plated | G1/4" female | 82, 83 | 840 | |
| Bronze bellows (CuSn6) | Brass (CuZn39Pb3) | 1/4"NPT female | G8 | G8.105 | Stainless steel 1.4435 | Brass nickel plated | G1/2" male | 72 | 809 | |
| Bronze bellows (CuSn6) | Brass (CuZn39Pb3) | 1/4"NPT female | G9 | G9.105 | Stainless steel 1.4435 | Brass nickel plated | G1/2" male | 73, 75 | 802 | |
| Bronze bellows (CuSn6) | Brass (CuZn39Pb3) | 1/4"NPT female | H1 | H1.107 | Stainless steel 1.4435 | Brass nickel plated | G1/2" male | 76, 77 | 804 | |
| Bronze bellows (CuSn6) | Brass (CuZn39Pb3) | 1/4"NPT female | H3 | H3.140 | Stainless steel 1.4435 | Brass nickel plated | G1/2" male | 78, 79 | 806 | |
| Bronze bellow (CuSn6) | Brass chemically nickel plated | G1/4" female | 72 | 950 | Stainless steel 1.4435 | Brass nickel plated | G1/2" male | 80, 81 | 808 | |
| Bronze bellow (CuSn6) | Brass chemically nickel plated | G1/4" female | 73, 75 | 951 | Stainless steel 1.4435 | Brass nickel plated | G1/2" male | 82, 83 | 841 | |
| Bronze bellow (CuSn6) | Brass chemically nickel plated | G1/4" female | 76, 77 | 953 | | | | | | |

| | XXX | XX | XX | XXXXXX | XX | XX |
|--------------------|--|----|----|--------|----|----|
| Fixing | Direct on sensor or housing | | | | | 00 |
| | With mounting bracket | | | | | 31 |
| Accessories | Lead seal (manipulation protection) | | | | | 16 |
| | Screwed cable gland M20x1.5 (EN50262)  | | | | | 07 |
| | Screwed cable gland M24x1.5 (DIN89280)  | | | | | 27 |
| | Screwed cable gland M18x1.5 (DIN89280)  | | | | | 40 |
| | Without screwed cable gland | | | | | 33 |
| | Railway version (UIC 616) | | | | | 28 |
| | Damping elements and snubber see data sheet H72258 | | | | | |

¹⁾ Switching differential not adjustable

²⁾ Not suitable for applications under vibration

Standard products (extra short lead time)

| Product No. | Type Code | Pressure range [bar] | Over pressure max. [bar] | Switching differential [bar] | Diameter Y [mm] | Length X [mm] |
|-------------|--------------|----------------------|--------------------------|------------------------------|-----------------|---------------|
| P1.5 | 900 2672 900 | -0.9 ... 1.5 | 10 | 0.1 (fixed) | 45 | 56.5 |
| P2.5 | 900 2675 901 | 0.2 ... 2.5 | 10 | 0.1 (fixed) | 45 | 56.5 |
| P4 | 900 2376 903 | 0 ... 4 | 12 | 0.2 (fixed) | 33 | 47 |
| P6 | 900 2377 903 | 0 ... 6 | 12 | 0.2 (fixed) | 33 | 47 |
| P10 | 900 2378 905 | 1 ... 10 | 24 | 0.4 (fixed) | 27 | 42.5 |
| P16 | 900 2379 905 | 1 ... 16 | 24 | 0.4 (fixed) | 27 | 42.5 |
| P25 | 900 2380 907 | 2 ... 25 | 40 | 1 (fixed) | 33 | 47 |
| P40 | 900 2381 907 | 4 ... 40 | 40 | 1 (fixed) | 33 | 47 |
| PS1.5 | 904 2672 900 | -0.9 ... 1.5 | 10 | 0.1 (fixed) | 45 | 56.5 |
| PS2.5 | 904 2675 901 | 0.2 ... 2.5 | 10 | 0.1 (fixed) | 45 | 56.5 |
| PS6 | 904 2377 903 | 0 ... 6 | 12 | 0.2 (fixed) | 33 | 47 |
| PS16 | 904 2379 905 | 1 ... 16 | 24 | 0.4 (fixed) | 27 | 42.5 |
| PS40 | 904 2381 907 | 4 ... 40 | 40 | 1 (fixed) | 27 | 42.5 |

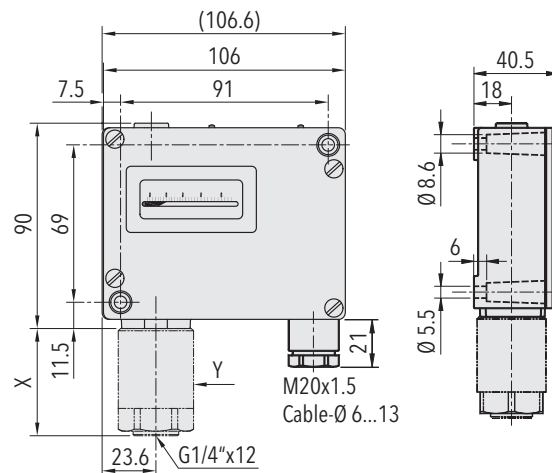

| Specifications | | |
|---------------------------------|--------------------------|--|
| Accuracy | Repeatability | ± 1.0 % FS typ. |
| | Scale accuracy typ. | ± 2.0 % FS typ. |
| | Switching differential | See table |
| Environmental conditions | Ambient temperature | -25°C ... +70°C |
| | Media temperature | -40°C ... +150°C |
| | Storage temperature | -25°C ... +85°C |
| | Protection | IP65 |
| | Humidity | Max. 95% relative |
| | Vibration | Switch 23/26, 5...25 Hz: ±1.6 mm 25...100 Hz: 4g Ranges 72, 73, 75, 5...50 Hz: 20 mm/sec. |
| | Shock | 50g/ 11ms |
| Mechanical Data | Sensor | See ordering information |
| | Housing | AlSi10Mg/ Epoxy coated |
| | Sealing | NBR |
| | Housing seal | EPDM 75 Sh |
| | Screwed cable gland | Brass nickel plated |
| | Male electrical plug | PA, Polyamide |
| | Mounting torque | max. 25 Nm |
| | Installation | any position |
| | Weight | ~ 710 g |
| Microswitch | Rating | See table |
| | Resistance of insulation | > 2 MΩ |
| | Dielectric strength | U ≤ 250V: 1.45 kV / U ≤ 500V: 2 kV terminal ground |
| | Life time (mechanical) | Microswitch 10/11: 20 Mio. cycles Microswitch 21: 0.5 Mio. cycles Microswitch 23/26: 0.3 Mio. cycles |
| Electrical connection | Electrical connections | Terminal screw |
| | Cable gland | M20x1.5 Cable-Ø 6...13 mm |
| | Terminal screw | 3 x 1.5...4 mm ² |

| Additional information | | |
|------------------------|--------------|--|
| Documents | Data sheet | www.trafag.com/H72252 |
| | Instructions | www.trafag.com/H71261 |
| | Flyer | www.trafag.com/H70911 |

Dimensions

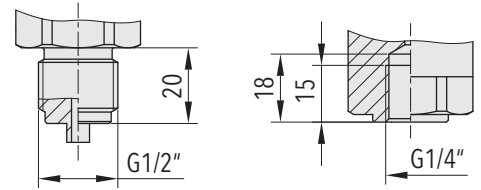
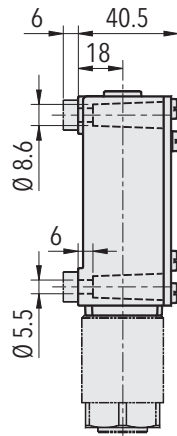
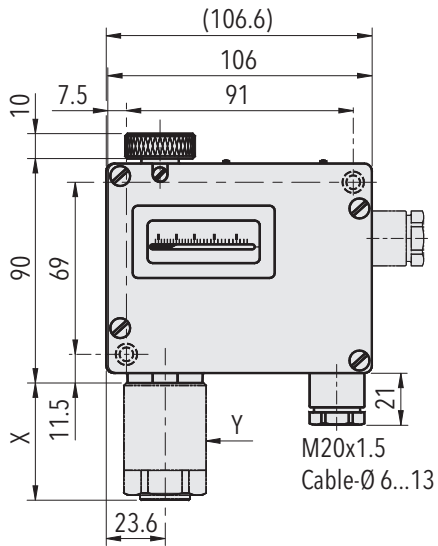

G1/2" male

G1/4" female

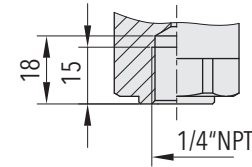

1/4" NPT female

Dimension X and Y see data sheet H72271

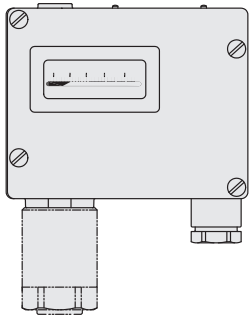

900.XX.XX.XXX.XX.XX

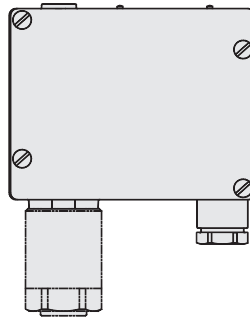

904.XX.XX.XXX.XX.XX

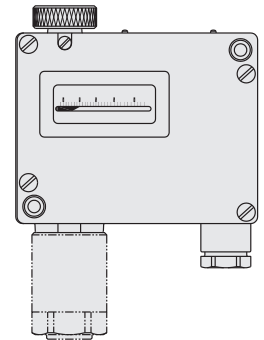

912.XX.XX.XXX.XX.XX

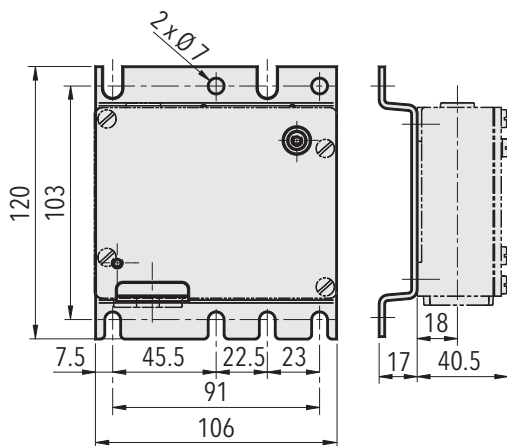

9XX.XX.XX.XXX.31.XX

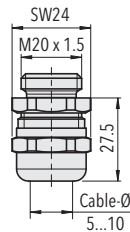

9XX.XX.XX.XXX.XX.07
M20x1.5

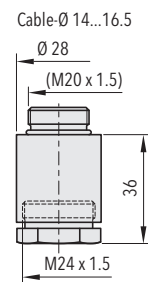

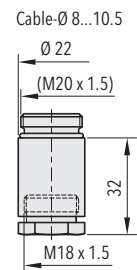

9XX.XX.XX.XXX.XX.27
M24x1.5



9XX.XX.XX.XXX.XX.40
M18x1.5

| Switching differential typ. | | | | | | |
|---|--------------|--|--------------------------|----------------------|----------------------|------------------------|
| Range of bellows sensor | [bar] | -0.9 ... 1.5 0.2 ... 1.6 0.2 ... 2.5 | 0 ... 4 0 ... 6 | 1 ... 10 1 ... 16 | 2 ... 25 4 ... 40 | 6 ... 60 10 ... 100 |
| P max. | [bar] | 10 | 12 | 24 | 40 | 100 |
| Microswitch 10 Switching differential fixed value, not adjustable | [bar] | 0.03 | 0.08 | 0.2 | 0.5 | 1.5 |
| Microswitch 11/21/23 Switching differential fixed value, not adjustable | [bar] | 0.1 | 0.2 | 0.4 | 1.0 | 3.0 |
| Microswitch 26 Switching differential fixed value, not adjustable | [bar] | 0.1 | 0.3 | 0.8 | 2.0 | 5.0 |
| | | | | | | |
| Range of bellows sensor | [psi] | 5 ... 50 | 10 ... 100 25 ... 200 | 50 ... 500 | 125 ... 1500 | |
| P max. | [psi] | 175 | 350 | 500 | 1500 | |
| Microswitch 10 Switching differential fixed value, not adjustable | [psi] | 1.2 | 3 | 7.5 | 22 | |
| Microswitch 11/21/23 Switching differential fixed value, not adjustable | [psi] | 3 | 6 | 14.5 | 44 | |
| Microswitch 26 Switching differential fixed value, not adjustable | [psi] | 4.4 | 12 | 30 | 72.5 | |

| Electrical data switch | | Rating Resistive Load (Inductive Load) | |
|--|---|--|--|
| Type | Features | AC | DC |
| 10 | Small switching differential (not recommended for applications under vibrations) | 125 V 10 (1.5) A 250 V 10 (1.25) A | 250 V 0.2 (0.02) A 125 V 0.4 (0.03) A 30 V 2 (1) A 14 V 15 (2.5) A |
| 11 | Average switching differential | 125 V 15 (1.5) A 250 V 15 (1.25) A 500 V 10 (0.75) A | 250 V 0.25 (0.03) A 125 V 0.5 (0.05) A 30 V 6 (1.5) A 14 V 15 (1.5) A |
| 23  | Improved vibration resistance; average switching differential | 125 V 15 (1.5) A 250 V 15 (1.25) A 500 V 10 (0.75) A | 250 V 0.3 (0.05) A 125 V 0.6 (0.1) A 30 V 15 (1.5) A 14 V 15 (1.5) A |
| 26  | High vibration resistance; average switching differential | 125 V 15 (1.5) A 250 V 15 (1.25) A 500 V 10 (0.75) A | 250 V 0.3 (0.2) A 125 V 0.75 (0.4) A 30 V 15 (1.5) A 14 V 15 (1.5) A |
| 21 | Gold plated contacts | 24 V 0.1 (0.1) A 12 V 1.0 (1.0) A 5 V 2.0 (2.0) A | 24 V 0.1 (0.1) A 12 V 1.0 (1.0) A 5 V 2.0 (2.0) A |

Electrical connection

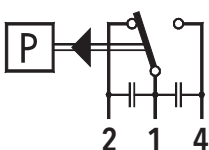

Switch 10/11/23

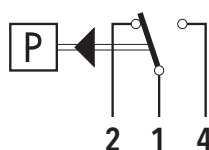

Switch 21/26

