

MARINE PRESSURE TRANSMITTER

Swiss based Trafag is a leading international supplier of high quality sensors and monitoring instruments for measurement of pressure and temperature. The economic pressure transmitter ECTN 8477 is based on the tried and true ECT line of transmitters. The wide media temperature range from -25 to 85°C in combination with a comprehensive set of features and options makes the ECTN 8477 pressure transmitter a versatile solution suitable for marine applications.



Applications

- Shipbuilding
- Engine manufacturing

Features

- Economical
- Good media compatibility
- Relative or absolute pressure measurement
- Titanium version optional

Technical Data

Measuring principle	Thick film on ceramic	Media temperature	-25°C ... +85°C 400 bar/5000 psi: -10°C ... +85°C
Measuring range	0 ... 1 to 0 ... 400 bar 0 ... 15 to 0 ... 5000 psi	Ambient temperature	-25°C ... +85°C
Output signal	4 ... 20 mA	Approval	DNV, GL, KRS, RINA
Accuracy @ 25°C typ.	± 0.5 % FS typ.		

09/2016

Data sheet H72322e

Subject to change

Ordering information/type code

				8477 . XX				XX	XX	XX	XX	XX
Measuring range ¹⁾	Pressure measurement range [bar]	Over pressure [bar]	Burst pressure [bar]	Pressure measurement range [psi]	Over pressure [psi]	Burst pressure [psi]						
		0 ... 1.0	2	3	71	0 ... 15	30	45	G1			
	0 ... 1.6	3.2	4.8	73	0 ... 20	40	70	G3				
	0 ... 2.5	5	7.5	75	0 ... 30	60	90	G5				
	0 ... 4	8	12	76	0 ... 50	100	150	G6				
	0 ... 6	12	15	77	0 ... 100	200	250	G7				
	0 ... 10	20	25	78	0 ... 150	300	375	G8				
	0 ... 16	32	40	79	0 ... 250	500	625	G9				
	0 ... 25	50	75	80	0 ... 400	800	1200	H0				
	0 ... 40	80	100	81	0 ... 500	1000	1250	H1				
	0 ... 60	120	180	82	0 ... 1000	2000	3000	H2				
	0 ... 100 ⁴⁾	200	300	83	0 ... 1500 ⁴⁾	3000	4500	H3				
	0 ... 160 ⁴⁾	320	480	85	0 ... 2000 ⁴⁾	4000	6000	H5				
	0 ... 250 ⁴⁾	500	750	74	0 ... 3000 ⁴⁾	6000	9000	G4				
	0 ... 400 ^{2) 4)}	800	1000	84	0 ... 5000 ^{2) 4)}	10000	12500	H4				
Sensor	Relative pressure, 1.4404/1.4435							59				
	Relative pressure, 1.4462 ⁴⁾							52				
	Relative pressure, Titanium Grade 5 ⁴⁾							53				
	Absolute pressure, 1.4404/1.4435 ³⁾							89				
	Absolute pressure, 1.4462 ^{3) 4)}							82				
	Absolute pressure, Titanium Grade 5 ^{3) 4)}							83				
Pressure connection	G1/4" female ⁴⁾							10				
	G1/4" male							17				
	G1/2" male ⁴⁾							21				
	1/4"NPT male ⁴⁾							30				
Electrical connection	Male electrical plug EN 175301-803-A, Mat. PA							05				
Output	Signal output	Load resistance	I (supply)	U (supply)								
	4 ... 20 mA	(U _{supply} -9V) / 20mA		9 ... 30 VDC				19				
Accessories	Seal FKM (-20°C ... +125°C)							61				
	Seal EPDM (-25°C ... +125°C)							63				
	Female electrical connector EN 175301-803-A (DIN43650-A)							58				
	Pressure peak damping element ø 0.4 mm							44				
	Pressure peak damping element ø 1.0 mm (for pressure connections 17 and 30)							40				
	Special electrical connection: Pin 1 + , Pin 2 - (only for output signal 4...20mA and male electrical plug EN175301-803-A / DIN43650-A)							92				

¹⁾ Extended overpressure as well as customized pressure ranges upon request

²⁾ Media -10°C ... +85°C

³⁾ Absolute ranges max. 40 bar

⁴⁾ Upon request

Standard products (extra short lead time)

Product No.	Type Code	Pressure range [bar]	Over pressure max. [bar]	Signal output	Supply [VDC]
ECTN1.0A	8477 71 5917 05 0000 0000 19 58 61	0 ... 1	2	4 ... 20 mA	9 ... 30
ECTN2.5A	8477 75 5917 05 0000 0000 19 58 61	0 ... 2.5	5	4 ... 20 mA	9 ... 30
ECTN4.0A	8477 76 5917 05 0000 0000 19 58 61	0 ... 4	8	4 ... 20 mA	9 ... 30
ECTN6.0A	8477 77 5917 05 0000 0000 19 58 61	0 ... 6	12	4 ... 20 mA	9 ... 30
ECTN10.0A	8477 78 5917 05 0000 0000 19 58 61	0 ... 10	20	4 ... 20 mA	9 ... 30
ECTN16.0A	8477 79 5917 05 0000 0000 19 58 61	0 ... 16	32	4 ... 20 mA	9 ... 30
ECTN25.0A	8477 80 5917 05 0000 0000 19 58 61	0 ... 25	50	4 ... 20 mA	9 ... 30
ECTN40.0A	8477 81 5917 05 0000 0000 19 58 61	0 ... 40	80	4 ... 20 mA	9 ... 30

Specifications		
Accuracy	TEB typ. @ -25 ... +85°C	± 3.0 % FS typ.
	Accuracy @ 25°C typ.	± 0.5 % FS typ.
	NLH @ 25°C (BSL) typ.	± 0.2 % FS typ.
	TC zero point and span typ.	± 0.03 % FS/K typ.
	Long term stability 1 year typ.	± 0.3 % FS typ.
Electrical Data	Output / supply voltage	4 ... 20 mA: 24 (9 ... 30) VDC
	Rise time	Typ. 1 ms/ 10...90 % Nominal pressure
	Switch-on-delay	100 ms
	Inverse-polarity protection, short-circuit strenght @ 25°C during 5 min.	4...20 mA: to $U_s = 30$ VDC
Environmental conditions	Media temperature	-25°C ... +85°C 400 bar/5000 psi: -10°C ... +85°C
	Ambient temperature	-25°C ... +85°C
	Protection ¹⁾	min. IP65
	Humidity	Max. 95 % relative
	Vibration	20g (10...2000 Hz)
	Shock	50g / 3 ms
EMC Protection	Emission	EN/IEC 61000-6-3
	Immunity	EN/IEC 61000-6-2
Mechanical Data	Sensor (wetted parts)	Ceramic, Al ₂ O ₃ (96 %)
	Pressure connection (wetted parts)	59/89: 1.4404/1.4435 (AISI316L) 52/82: 1.4462 (AISI318LN) 53/83: Titanium Grade 5
	Housing	59/89: 1.4404/1.4435 (AISI316L) 52/82: 1.4462 (AISI318LN) 53/83: Titanium Grade 5
	Sealing	FKM 70 Sh, EPDM
	Male electrical plug	See ordering information
	Weight	~ 110 g
	Mounting torque	15...20 Nm

¹⁾ See electrical connection

Measuring accuracy 0.5 %

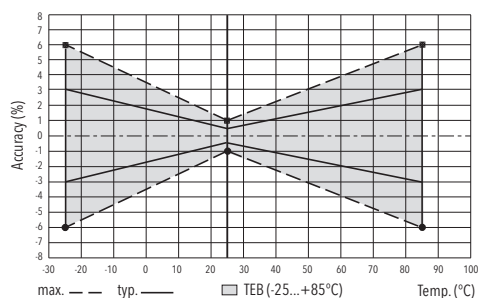

Dimensions

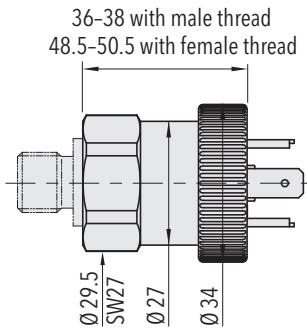

8477.XX.XXXX.05.XX.XX

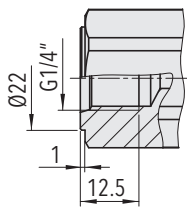

8477.XX.XX10.XX.XX.XX

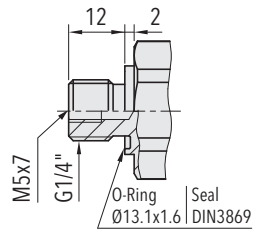

8477.XX.XX17.XX.XX.XX

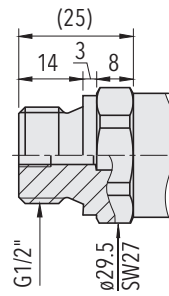

8477.XX.XX21.XX.XX.XX

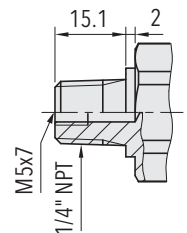

8477.XX.XX30.XX.XX.XX

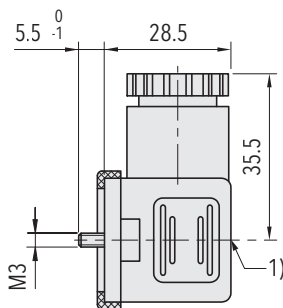

1) Tightening torque 50...60Ncm

8477.XX.XXXX.XX.XX.58

Electrical connection

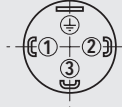
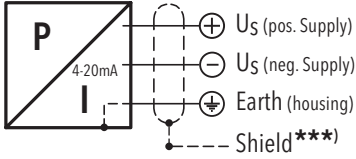
		Protection / electrical connection	
		IP65*)	
		Industrial standard EN175301-803A 05 	
Output signal	 <p>4-20mA</p> <p>U_S (pos. Supply)</p> <p>U_S (neg. Supply)</p> <p>Earth (housing)</p> <p>Shield***)</p>	Standard	with accessory 92
		<p>2</p> <p>1</p> <p>⊕</p>	<p>1</p> <p>2</p> <p>⊕</p>
8477 .XX.XXXX.XX.19			

*) Provided female connector is mounted according to instructions

***) Only cable versions or female plug with shield connection

Additional information

Documents

Data sheet	www.trafag.com/H72322
Instructions	www.trafag.com/H73324
Flyer	www.trafag.com/H70688