

HIGH ACCURACY PRESSURE TRANSMITTER

Swiss based Trafag is a leading international supplier of high quality sensors and monitoring instruments for measurement of pressure and temperature.



Applications

- Test benches
- Test equipment

Features

- Accuracy up to 0.05 % FS
- Versions with frontal or with flush diaphragm
- Media temperature to 125°C
- EMC protection, IEC 61000

10/2019

Data sheet H72354a

Technical Data

Measuring principle	Piezoresistive	Media temperature	-40°C ... +125°C
Measuring range	0 ... 0.1 to 0 ... 100 bar	Ambient temperature	-40°C ... +125°C
Output signal	4 ... 20 mA, 0 ... 5 VDC, 0 ... 10 VDC		

Subject to change

Ordering information/type code

				8845 . XX	XX	XX	XX	XX	XX	
Measuring range ¹⁾	Pressure measurement range [bar]	Over pressure [bar]	Burst pressure [bar]							
	0 ... 0.1	3	850	66	0 ... 1.5	40	12000	F6		
	0 ... 0.16	3	850	67	0 ... 2	40	12000	F7		
	0 ... 0.2	3	850	68	0 ... 2.5	40	12000	F8		
	0 ... 0.4	3	850	69	0 ... 5	40	12000	F9		
	0 ... 0.6	3	850	70	0 ... 7.5	40	12000	G0		
	0 ... 1	3	850	71	0 ... 15	40	12000	G1		
	0 ... 1.6	4.8	850	73	0 ... 20	60	12000	G3		
	0 ... 2.5	7.5	850	75	0 ... 30	100	12000	G5		
	0 ... 4	12	850	76	0 ... 50	150	12000	G6		
	0 ... 6	18	850	77	0 ... 100	250	12000	G7		
	0 ... 10	30	850	78	0 ... 150	400	12000	G8		
	0 ... 16	48	850	79	0 ... 250	600	12000	G9		
	0 ... 25	75	850	80	0 ... 400	1000	12000	H0		
	0 ... 40	120	850	81	0 ... 500	1700	12000	H1		
	0 ... 60	180	850	82	0 ... 1000	2500	12000	H2		
	0 ... 100	300	850	83	0 ... 1500	4000	12000	H3		
	Sensor	Type 03 relative								P3
		Type 03 absolute								A3
Pressure connection	1/4" NPT male								30	
	1/2" NPT male								39	
	G1/4" female								10	
	G1/4" male								15	
	G1/2" male								21	
	G1/2" male, frontal membrane								31	
	G1/2" male, flush membrane								32	
Electrical connection	Male electrical connector EN 175301-803-A (DIN43650-A)								05	
	Male electrical connector: Binder 723, 5-pole								14	
	Male electrical connector MIL-C 26482, 10 - 6								02	
	Male electrical connector M12x1, 4-pole								32	
Output signal	Signal output	Load resistance	I (supply)	U (supply)						
	4 ... 20 mA	(U _{supply} -9 V) / 20 mA		9 ... 33 VDC						
	0 ... 5 VDC	≥ 10 kΩ	≤ 3 mA	10 ... 30 VDC						
	0 ... 10 VDC	≥ 10 kΩ	≤ 3 mA	12 ... 30 VDC						
Accessories	Seal FKM, -18°C ... +125°C (Standard)								61	
	Seal EPDM, -40°C ... +125°C								63	
	Special oil filling: Anderol Food (for food applications)								94	
	Female electrical plug EN 175301-803-A (DIN43650-A)								58	
	Female electrical plug Binder 723, 5-pole, metal								37	
	Female electrical plug MIL-C 26482, 10 - 6, metal								32	
	Compensated temperature range -40°C ... +125°C								TA	
	Compensated temperature range -25°C ... +100°C								TB	
	Compensated temperature range 0°C ... +70°C								TC	
	Pressure peak damping element ²⁾								DE	

¹⁾ Customized pressure ranges upon request

²⁾ Only with pressure connection 30, 39, 15, 21

Specifications		
Electrical Data	Output / supply voltage	4 ... 20 mA: 9 ... 33 VDC 0 ... 5 VDC: 10 ... 30 VDC 0 ... 10 VDC: 12 ... 30 VDC
	Environmental conditions	Media temperature
	Ambient temperature	-40°C ... +125°C
	Protection ¹⁾	Min. IP40
	Vibration	EN 60068-2-6: 10 g (4...2000 Hz)
	Shock	EN 60068-2-27: 100 g/ 6 ms
EMC Protection	Emission	EN 61000-4-3: 10 V/m
	Immunity	IEC 61000-4-2: 8 kV contact/15 kV air
Mechanical Data	Sensor (wetted parts)	1.4435 (AISI316L)
	Pressure connection (wetted parts)	1.4435 (AISI316L)
	Housing	1.4435 (AISI316L)
	Sealing	FKM 70 Sh / EPDM
	Male electrical connector	See ordering information
	Weight	~ 220 g
	Mounting torque	max. 30 Nm

¹⁾ Provided female electrical plug is mounted according to instructions

Accuracy			
Pressure measuring range	[bar]	0.1 ... < 1.0	0 ... 1 to 0 ... 100
NLH @ +25°C (BSL through 0)	[% FS max.]	± 0.1	± 0.05
TEB @ 0 ... +70°C ²⁾	[% FS typ.]	± 0.2	± 0.15
	[% FS max.]	± 0.4	± 0.3
TEB @ -25 ... +100°C ²⁾	[% FS typ.]	± 0.3	± 0.2
	[% FS max.]	± 0.5	± 0.4
TEB @ -40 ... +125°C ²⁾	[% FS typ.]	± 0.4	± 0.3
	[% FS max.]	± 0.7	± 0.6
Long term stability 1 year	typ.	< 1 mbar	< 0.1 % FS
	max.	< 2 mbar	< 0.2 % FS

²⁾ Total errors including characteristics curve deviation and temperature errors at maximum signal span

Dimensions

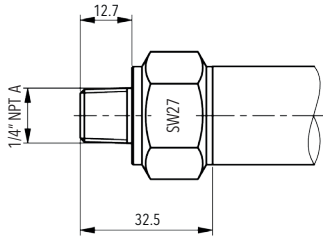

8845.XX.XX30.XX.XX.XX
 > 25 bar

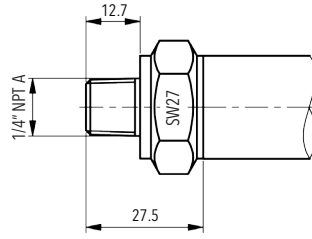

8845.XX.XX30.XX.XX.XX
 ≤ 25 bar

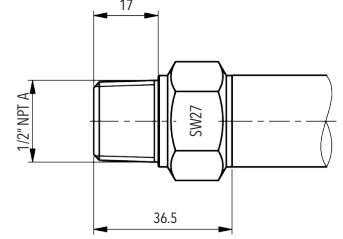

8845.XX.XX39.XX.XX.XX
 > 25 bar

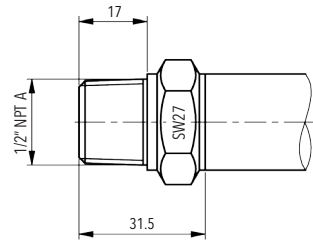

8845.XX.XX39.XX.XX.XX
 ≤ 25 bar

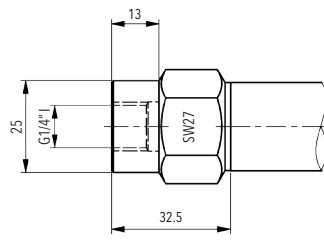

8845.XX.XX10.XX.XX.XX
 > 25 bar

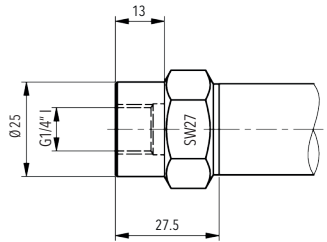

8845.XX.XX10.XX.XX.XX
 ≤ 25 bar

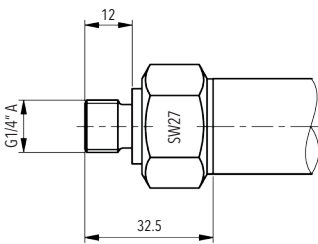

8845.XX.XX15.XX.XX.XX
 > 25 bar

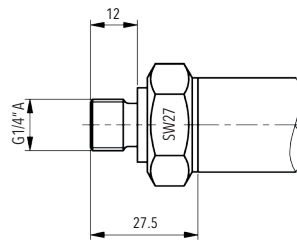

8845.XX.XX15.XX.XX.XX
 ≤ 25 bar

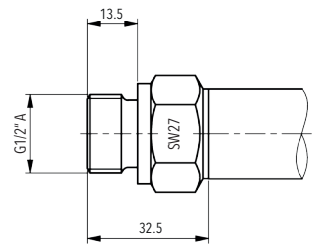

8845.XX.XX21.XX.XX.XX
 > 25 bar

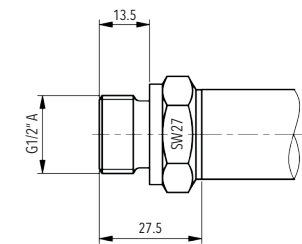

8845.XX.XX21.XX.XX.XX
 ≤ 25 bar

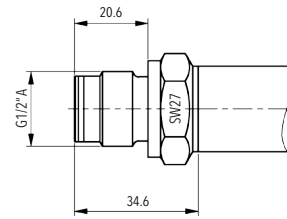

8845.XX.XX31.XX.XX.XX

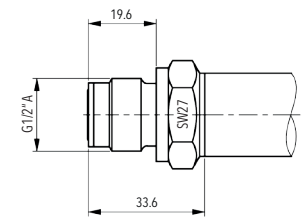

8845.XX.XX32.XX.XX.XX

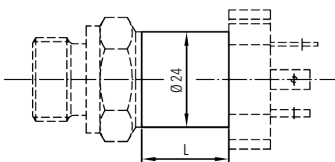

8845.XX.XXXX.XX.XX.TA
8845.XX.XXXX.XX.XX.TB
8845.XX.XXXX.XX.XX.TC

Electrical connection

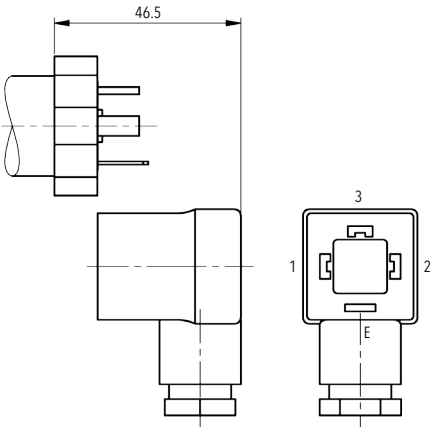

8845.XX.XXXX.05.XX.58

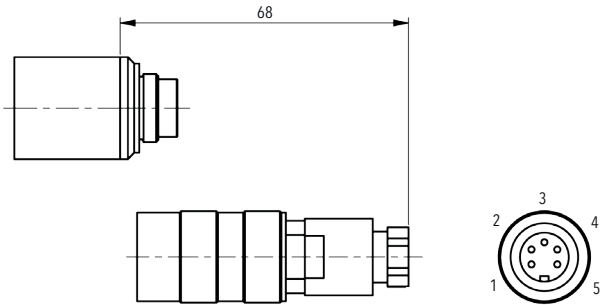

8845.XX.XXXX.14.XX.37

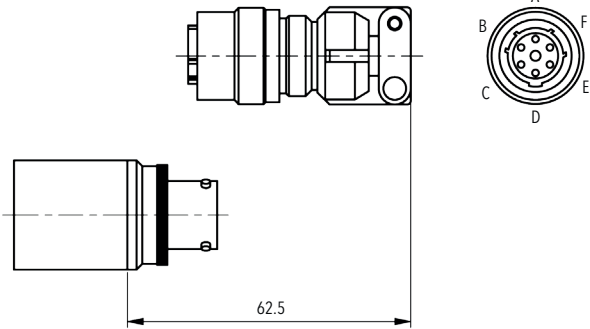

8845.XX.XXXX.02.XX.32

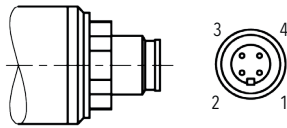

8845.XX.XXXX.32.XX.XX

Electrical connection

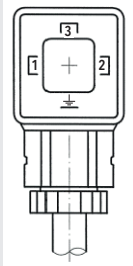
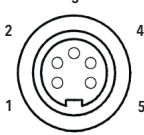
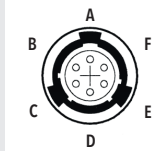
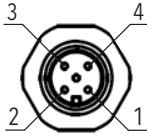
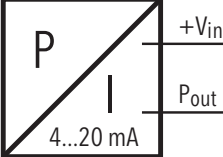
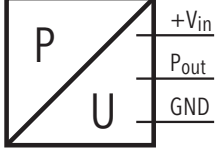
		Protection / electrical connection			
		IP65	IP67	IP40	IP67
		Industrial standard EN175301-803A (DIN43650)	Binder 723 5-pole	MIL-C 26482 10 - 6	M12x1 4-pole
		05 *	14 *	02 *	32 *
					
Output signal	 8845.xx.xxxx.xx.19	1 2	3 1	A C	4 3
	 8845.xx.xxxx.xx.14/17	1 2 3	3 1 4	A C B	4 3 1

* View on female electrical plug

Additional information

Documents

Data sheet	www.trafag.com/H72354
Instructions	www.trafag.com/H73227
Flyer	www.trafag.com/H70609