

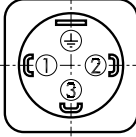





Elektrischer Anschluss / Raccordement électrique / Electrical connection

Schutzart/ Protection Ausführung Exécution Execution Ausgangssignal Signal de sortie Output	IP65 ²⁾ EN175301-803-A (DIN 43650-A) 04 	IP69K Cable* 78 Abschirmung écran / shield 
 <p>8264.XX.XXXX.XX.19</p>	standard 2 	with accessory 92 1  2 
		brown black yellow/green

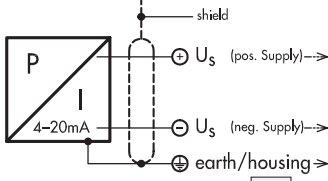
²⁾ nur mit vorschriftsmässig montierter Kabeldose gültig
valable seulement avec fiche femelle montée selon instructions
provided female connector is mounted according to instructions

* Entlüftung über das Kabelende/ ventilation par extrémité du câble/
ventilation via cable end

Output	Load resistance	I _{SUPPLY}	U _{SUPPLY}	
4 ...20 mA	(U _{Supply} -9V)/20mA		9 ... 32 VDC	8264.XX.XXXX.XX.19 ..

Anziehdrehmoment Druckanschluss/ Couple de serrage raccord de pression / Torque moment pressure connection

8264.XX.XX10 .XX...	G1/4":	32 ... 40 Nm
8264.XX.XX18 .XX...	G1/8":	16 ... 20 Nm
8264.XX.XX17 .XX...	M10x1.0:	16 ... 20 Nm
8264.XX.XXXX.XX.XX41 ...	Flange:	4.5... 6 Nm

Betriebstemperatur / Température de service / Operating temperature

-40°C... +100°C (-40°F...+210°F)

Lagertemperatur / Température de stockage / Storage temperature

-40°C... +100°C (-40°F...+210°F)

Überdruck / Surpression / Overpressure

Nenndruck pression nominal nominal pressure		Überdruck Surpression Over pressure	
[bar]	[psi]	[bar]	[psi]
0 ... 2.5	0 ... 30	5	70
0 ... 4.0	0 ... 50	8	115
0 ... 6.0	0 ... 100	12	170
0 ... 10	0 ... 150	20	290
0 ... 16	0 ... 250	32	464
0 ... 25	0 ... 400	50	725
0 ... 40	0 ... 500	80	1160
0 ... 60	0 ... 1000	120	1740
0 ... 100	0 ... 1500	200	2900
0 ... 160 ¹⁾	0 ... 2000	320	4640
0 ... 250 ¹⁾	0 ... 3000	500	7250

¹⁾ Nur bei Druckanschluss G1/4" / seulement connecteur de pression G1/4" / Only pressure connection G1/4"

Massbilder / Cotes d'encombrement / Dimensions

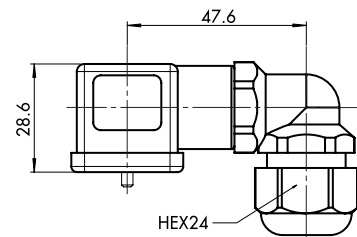
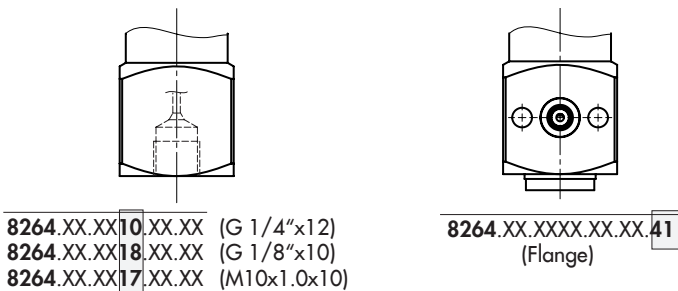
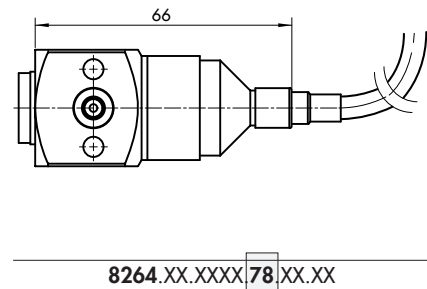
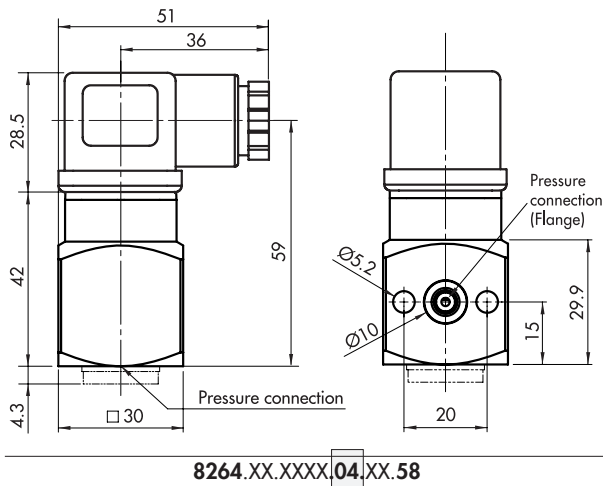

Kabelmontage/Montage du câble/Cable mounting

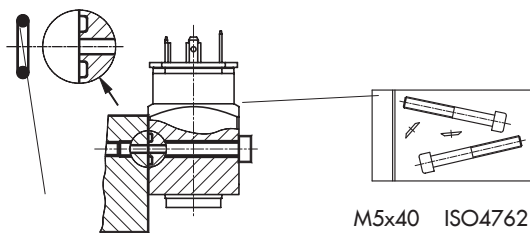

O-Ring: \varnothing 6.75x1.78 (NBR 90 Shore)

8264.XX.XXXX.XX.XX.41.XX... 8264.XX.XXXX.XX.XX.V3.XX...

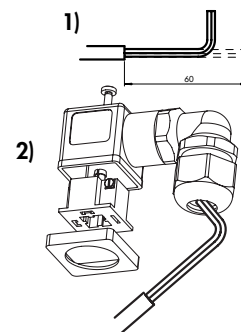

8264.XX.XXXX.04.XX.55