



FMCW Radar Level Transmitter



www.fine-tek.com

PRODUCT INTRODUCTION

FMCW Radar level transmitter is a non contact measuring device, which is suitable for high temp., high pressure, and corrosive applications. It is easy to install and free of maintenance, especially for the high accuracy requirement environment.

PRINCIPLE

FMCW radar adopts a high frequency signal, which is emitted via an antenna and swipes frequency increment by 0.5GHz during the measurement, reflected by the target surface and received at a time delay. The frequency difference, which is calculated from the transmitting frequency and the received frequency, which is directly proportional to the measured distance (or material surface).

The frequency difference then is processed by Fast Fourier Transformation (FFT) to identify the signal in Intermedium Frequency (IF). This FMCW radar is innate with signal / noise enhancement and filtering of echo-back via Phase-Lock Loop (PLL) circuit that is the best solution for complex environment and high accuracy measurement.

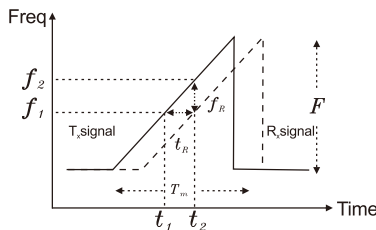

Design formula

$$Slop = \frac{F}{T_m} = \frac{f_R}{t_R} = \frac{f_R}{\frac{2R}{c}} \quad t_R = \frac{2R}{c}$$

$$R = \frac{F_R \times c \times T_m}{2F}$$

JFR-100 LINEARITY DIAGRAM

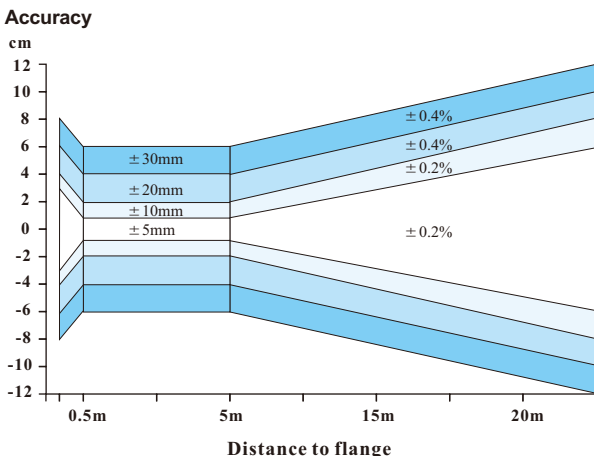

FEATURES

- Non contact measuring
- Corrosive and toxic liquid, hydrocarbons, slurries
- Not affected by specific gravity, pressure, temperature, viscosity, foam, and dust
- 5 digits LCM display
- Indicate signal wave inside the silo.
- Selection of Different Measurement unit(m, cm, mm, inch, ft, %, mA)
- Measuring distance and actual level.
- Language selection of traditional Chinese, simplified Chinese, English.
- 4-20mA/ 4 lead wires
- Modbus RS-485 to enhance isolation and easy for remote control.
- CE standards for isolation(EFT 2000V, B class or better)
- Suitable for mid-range signal
- 4mA, 20mA output
- Set functions to the continuous measuring device via FAS software.
- Isolated circuit design.

TEST STANDARDS

- High voltage : IEC60947-2
- Isolated resistance : IEC60092-504
- Power supply change : IEC60092-504
- Power supply failure : IEC60092-504
- Electrical burst testing : IEC61000-4-4
- Voltage DIPS : IEC61000-4-11
- Humidity : IEC60068-2-30
- High/Low temperature test : IEC60068-2-1&2
- Protection rating IP65 : IEC60529

SPECIFICATION

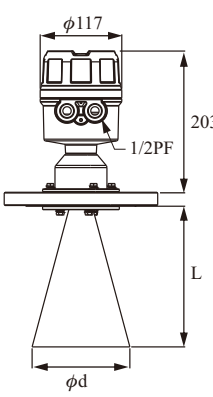
Dimensions (Unit:mm)											
	<table border="1" style="margin-left: auto; margin-right: auto;"> <thead> <tr> <th>Antenna</th> <th>Length(L)</th> <th>Opening(φd)</th> </tr> </thead> <tbody> <tr> <td>Type3</td> <td>202</td> <td>140</td> </tr> <tr> <td>Type2</td> <td>126</td> <td>100</td> </tr> </tbody> </table>			Antenna	Length(L)	Opening(φd)	Type3	202	140	Type2	126
Antenna	Length(L)	Opening(φd)									
Type3	202	140									
Type2	126	100									
Model	JFR-1□□-A	JFR-1□□-B	JFR-1□□-C								
Accuracy (1m~5m)	± 5mm	± 10mm	± 20mm								
Repeatability	± 2.5mm	± 5mm	± 10mm								
Measuring range	Type2: 20m, Type3: 30m										
Digital communication	RS485(Isolated)										
Ambient temperature	-20~70°C										
Operating temperature	-20~200°C										
Operating pressure	0~40 bar										
Frequency	X Band										
Analog output	4~20mA / 4 Wire										
Power consumption	100mA/ 24Vdc										
Protection rating	IP65										
Min. dielectric constant	2.5										
Power supply	24Vdc ± 10%										
Local display	5 digits LCM display										
Housing material	Aluminum										
Antenna type	Horn										
Antenna material	SUS 304/ 316/ ETFE Coating										
Sampling rate	1sec.										
Blind distance	0.5m										

SPECIFICATION

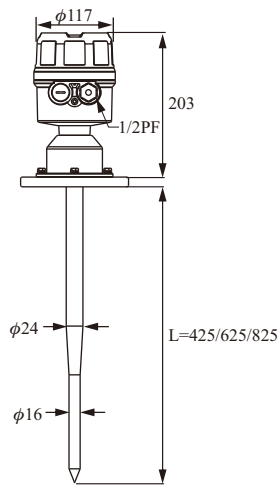
<p>Dimensions (Unit:mm)</p>		
<p>Model</p>	<p>JFR-1□-F-C</p>	<p>JFR-1□-F-D</p>
<p>Accuracy (1m~5m)</p>	<p>± 20mm</p>	<p>± 30mm</p>
<p>Repeatability</p>	<p>± 10mm</p>	<p>± 15mm</p>
<p>Measuring range</p>	<p>10m</p>	
<p>Digital communication</p>	<p>RS485(Isolated)</p>	
<p>Ambient temperature</p>	<p>-20~70°C</p>	
<p>Operating temperature</p>	<p>-20~150°C</p>	
<p>Operating pressure</p>	<p>0~16 bar</p>	
<p>Frequency</p>	<p>X Band</p>	
<p>Analog output</p>	<p>4~20mA/ 4 Wire</p>	
<p>Power consumption</p>	<p>100mA/ 24Vdc</p>	
<p>Protection rating</p>	<p>IP65</p>	
<p>Min. dielectric constant</p>	<p>4</p>	
<p>Power supply</p>	<p>24Vdc ± 10%</p>	
<p>Local display</p>	<p>5 digits LCM display</p>	
<p>Housing material</p>	<p>Aluminum</p>	
<p>Antenna type</p>	<p>Rod</p>	
<p>Antenna material</p>	<p>PTFE</p>	
<p>Sampling rate</p>	<p>1sec.</p>	
<p>Blind distance</p>	<p>0.6m</p>	

WIRING/CALIBRATION

WIRING INFORMATION

RS485 wiring

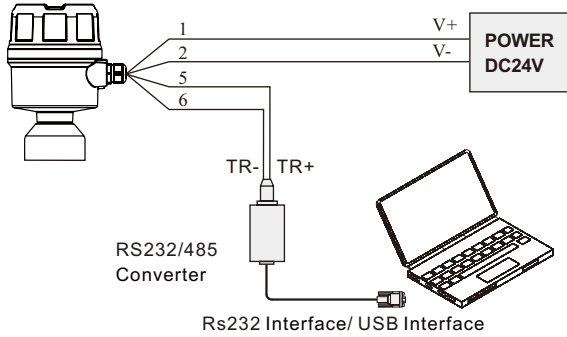

JFR Series and Indicator(External Power)

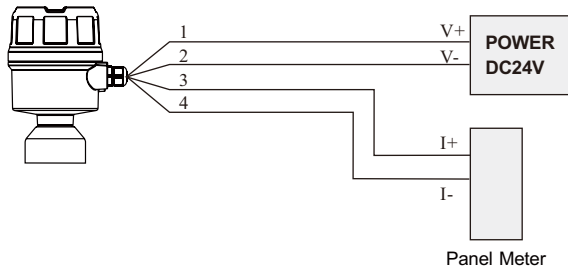

JFR Series and Indicator(Powered by panel meter)



WIRING DIAGRAM

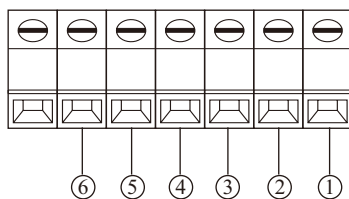

- ① Power Supply: V+
- ② Power Supply: V-
- ③ Analog Output: I+ (4~20mA)
- ④ Analog Output: I- (4~20mA)
- ⑤ Communication: TR+ (Rs485)
- ⑥ Communication: TR- (RS485)

CALIBRATION

Two ways to calibrate the JFR Series:

1. With display/adjustment module
2. By PC based FAS software

Adjustment module is an adjustment tool with 4 buttons to click on. It also has a transparent window to allow display reading.

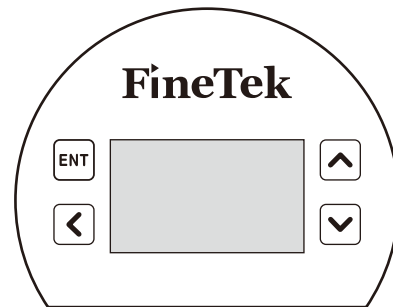

5 digits LCM display

[**ENT**] Button

- Enter Edit status
- Confirm Edit
- Confirm parameter modification

[**←**] Button

- Select Edit
- Select parameter
- Parameter

[**↑**] Button

- Return
- Cancel

[**↓**] Button

- Increase
- Select

QUICK SETUP

FineTek
FineTek Co. Ltd.
WWW.FINE-TEK.COM

FINE-TEK
16.272
M CM MM INCH FT % MA

Press \uparrow + ENT for 3 seconds to enter main menu

MAIN MENU 1
▶▶ SETTING
DISPLAY
DIAGRAM
SERVICE

Click on "SETTING MENU 1.1" to enter

SETTING MENU 1.1
▶▶ LOW POINT
HIGH POINT
BLIND AREA
MAX RANGE

Click on "LOW POINT 1.1.1" to enter

LOW POINT 1.1.1
04500
MM

Enter distance between flange and low level by using \leftarrow and \checkmark . Click on ENT to save and return to 1.1

SETTING MENU 1.1
▶▶ HIGH POINT
BLIND AREA
MAX RANGE

Click on "HIGH POINT 1.1.2" to enter

HIGH POINT 1.1.2
00000
MM

Enter distance between flange and high level by using \leftarrow and \checkmark . Click on ENT to save and return to 1.1

SETTING MENU 1.1
▶▶ LOW POINT
HIGH POINT
BLIND AREA
MAX RANGE

Click on "BLIND AREA 1.1.5" to enter

BLIND AREA 1.1.5
00500
MM

Enter blind distance counting from flange by using \leftarrow and \checkmark . Click on ENT to save and return to 1.1

SETTING MENU 1.1
▶▶ LOW POINT
HIGH POINT
BLIND AREA
MAX RANGE

Click on "MAX RANGE 1.1.6" to enter

MAX RANGE 1.1.6
04500
MM

Enter tank height, save and go to setting 1.1

SETTING MENU 1.1
▶▶ LOW POINT
HIGH POINT
BLIND AREA
MAX RANGE

Press \uparrow to enter main menu

MAIN MENU 1
▶▶ SETTING
DISPLAY
DIAGRAM
SERVICE

Click on "DISPLAY MENU 1.2" to enter

DISPLAY MENU 1.2
▶▶ DISPLAY CONTEXT
LCD CONTRAST

Click on "DISPLAY CONTENT 1.2.1" to enter

DISPLAY CONTEXT 1.2.1
▶▶ \checkmark DISTANCE
OBJECT HEIGHT
PERCENTAGE
CURRENT MENU

Save and click on ENT to return to 1.2. click on \uparrow twice to return to the display.

FINE-TEK
16.272
M CM MM INCH FT % MA

DIAGRAM

Measurement bench-mark starts at contact surface of connection.

- ① Low level calibration (menu 1.1.1)
- ② High level calibration (menu 1.1.2)
- ③ Blind Distance (menu 1.1.5)
- ④ Measuring Distance Setup (menu 1.1.6)

Note: Be aware of blind distance when measuring material high level.(Shown in ③)

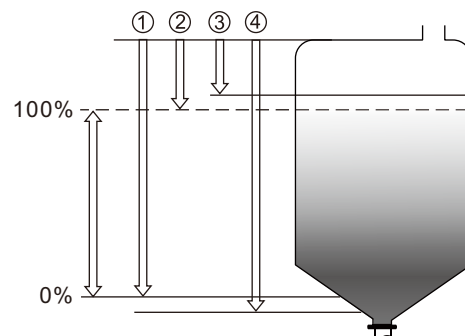

SOFTWARE SETUP CALIBRATION

Software Setup Calibration(FAS)

FAS calibration software can be utilized with JFR Series via RS485/RS232 to allow tank data reading and setup from PC.

Parameter Description

Low Point: Low point(4mA), measuring range from flange to low level.

High Point: High point(20mA), measuring range from flange to high level.

Blind Area: Blind distance, distance starts from flange surface.

Max. Distance: Measuring range between low point and high point.

FAS Operation Instruction

1. Turn on FAS software
2. Go to Address, then choose 9600, COM5 from baudrate
3. Click on Connect.
4. Press "Stop Sync" to change parameter.
5. Press "GetFFT" to read wave reflection diagram.
Press "Stop Sync" to change preset parameter.

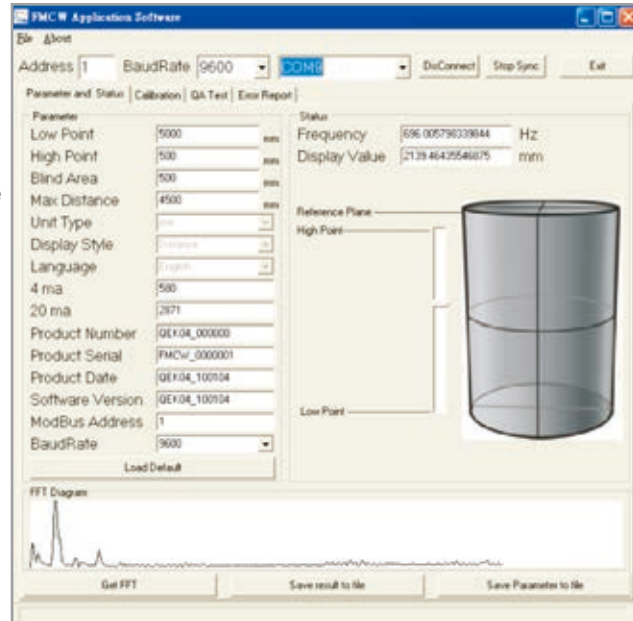

INSTALLATION

If the JFR-13 is installed on a neck, refer to the limitation on the length and the diameter as below.

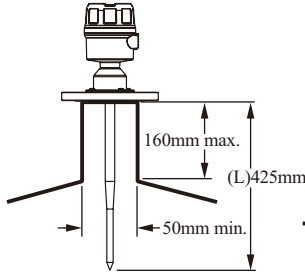

Device has to be installed away from the tank wall to avoid disturbance caused by reflection.

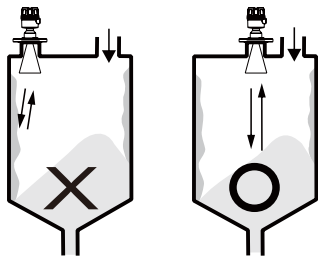

Device has to be installed away from the tank wall to avoid incorrect reflection.

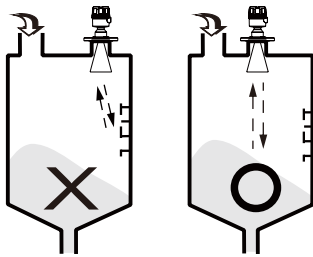

A reflector is recommended to be installed when there is disturbing obstacle to avoid false reflection.

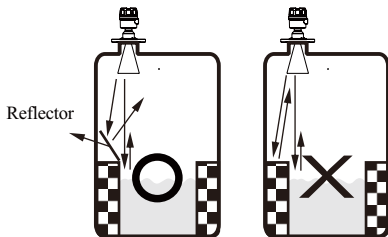

Sun/rain block is recommended for outdoor application.

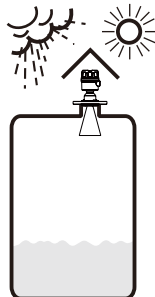

The horn of the JFR-100 can not hide in the neck. The horn has to expose itself to the tank by 0.39" at least

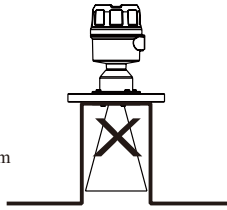

The axis direction of FMCW should be parallel with the wall, or be in orthogonal with the surface. For Install, the distance from the wall should $>1/3 D$, and the height from the surface $>1/5 H$ (Measurement Depth) is recommended.

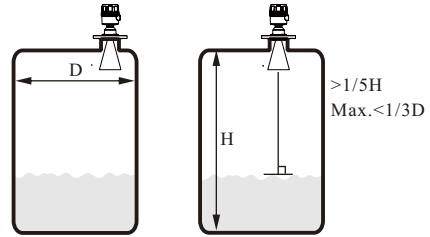

The turbulent or stirring will make the bubble and vortex that might interface with the measurement, it is recommended to install wave shield tube with vent hole. To avoid from this situation.

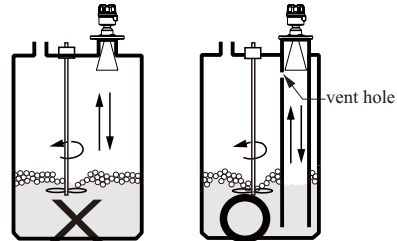

Device is to be installed away from material inlet to avoid disturbance caused by material or other obstacles.

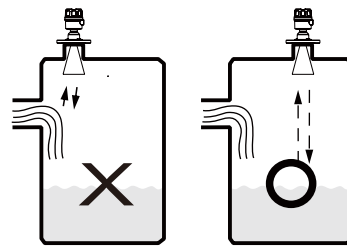

Please avoid center installation for arched top tanks for possible multiple reflection.

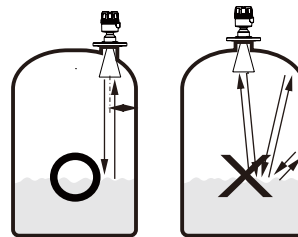

The best installation position for cone shape tank with flat top is at the center spot for full measuring range.

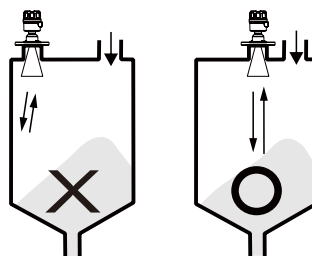

ORDERING INFORMATION

JFR-1 - - 0 - 0 - R01

Type

- 0: Horn Antenna Type3
(Length 202mm, opening 140mm) Standard
- 1: Horn Antenna Type2
(Length 126mm, opening 100mm)
- 3: Rod Antenna
(Length 425mm) Standard
- 4: Rod Antenna
(Length 625mm)
- 5: Rod Antenna
(Length 825mm)

Material

- 0: SUS304---Horn Antenna
- 6: SUS316---Horn Antenna
- E: ETFE-----Horn Antenna with ETFE coating
- F: PTFE-----Rod Antenna

Accuracy

- A: ± 5mm B: ± 10mm
- C: ± 20mm D: ± 30mm

Flang connection

Size for flange or screw		Pressure range or other	
G: 2-1/2"(65A)	I: 4"(100A)	M: 5kg/cm ² JIS	W: PN10 (10Bar)
H: 3" (80A)	J: 5"(125A)	N: 10kg/cm ² JIS	X: PN16 (16Bar)
	K: 6"(150A)	O: 150Lbs ANSI	Y: PN25 (25Bar)
	S: Others	P: 300Lbs ANSI	Z: PN40 (40Bar)
			S: Others

※ Please do check Radar antenna can be direct fitted in flange connection and nozzle

Below is the suggestion

(1) Horn Antenna

Type	Opening	Flange size
Type3	140mm	6"
Type2	100mm	4"

(2) Rod Antenna

Minimum size of flange is 2-1/2"

Flange Material

- Metal 0: SUS304 5: SS41 zinc coating 6: SUS316
- Plastic P: PP E: PTFE

EXAMPLES-OF-TANK-MOUNTING

- [FC/FD] Mini Float/Magnetic Float Level Switch
- [FG] Magnetic Float Level Transmitter
- [FF] Side Mounting Float Switch
- [FA/FB] Cable Float Level Switch
- [SP] Thermal Dispersion Flow Switch
- [SF] Paddle Flow Switch
- [SD] Optical Level Switch
- [SE] Rotary Paddle Level Switch
- [SA] Capacitance Level Switch
- [EC] Pressure Level Transmitter
- [SC] Vibrating Probe Level Switch
- [SC] Tuning Fork Level Switch
- [EB] RF-Capacitance Level Transmitter
- [SB] RF-Capacitance / Admittance Level Switch
- [EG] Magnetostrictive Level Transmitter
- [EF] By-Pass Level Transmitter
- [MEF] Mini By-Pass Level Transmitter
- [EA] Ultrasonic Level Transmitter
- [JFR] FMCW Radar Level Transmitter
- [EE] Electromechanical Level Measuring System
- [ED] Speed Monitor
- [SRT/SRS] Conveyer Belt Misalignment Switch & Safety Cable Pull Switch
- [PB/PM] Microprocessor Based Bargraphic Display Scaling Meter
- [BRD/AE] Valve and Controller for Dust Collector System
- [BAS/BAH/BVP] Air Hammer
- [BVK/BVR/BVT] Pneumatic Vibrator

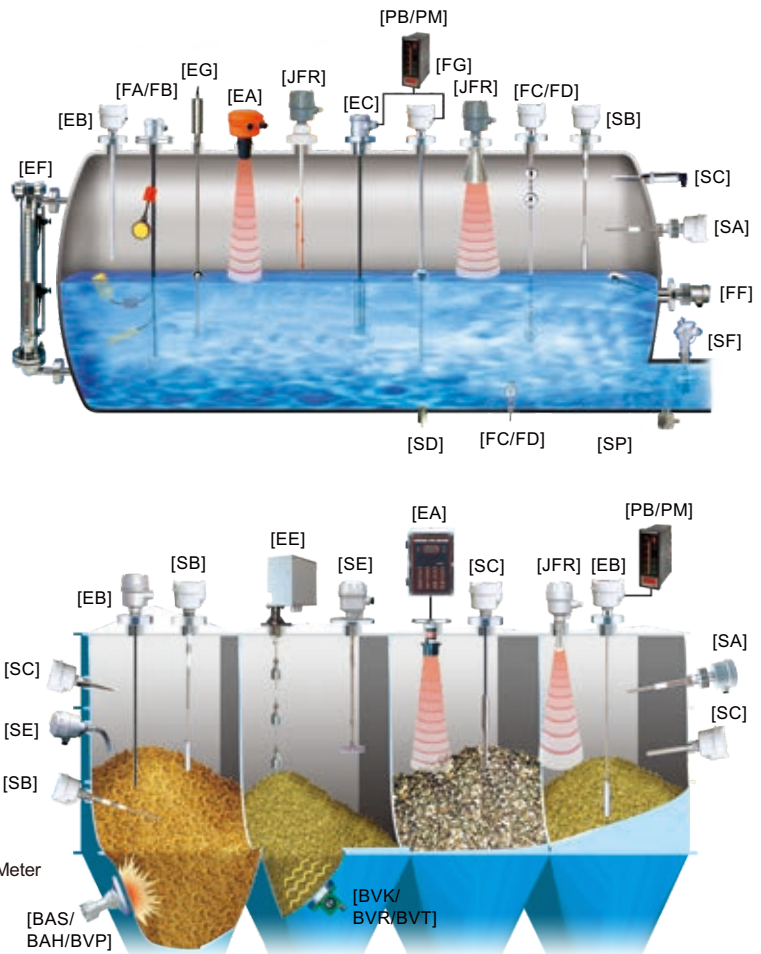

FineTek Co., Ltd.

No.16, Tzuchiang St., Tucheng Industrial Park, New Taipei City 236, Taiwan.
 TEL: 886 2 2269 6789 FAX: 886 2 2268 6682
 Email: info@fine-tek.com http://www.fine-tek.com

Fine automation (ShangHai) Co., Ltd.

No.451 DuHui Rd, MinHang District, Shanghai, China 201109
 TEL: 86 21 6490 7260 FAX: 86 21 6490 7276
 Email: info.sh@fine-tek.com http://www.fineautomation.com.cn

FineTek Pte Ltd.

No. 60 Kaki Bukit Place, #07-06 Eunos Techpark 2
 Lobby B, Singapore 415979
 TEL: 65 6452 6340 FAX: 65 6734 1878
 Email: info.sg@fine-tek.com

FineTeK GmbH

Frankfurter Str. 62, OG D-65428 Ruesselsehim, Germany
 TEL: 49 6142 17608 0 FAX: 49 6142 17608 20
 Email: info@fine-tek.de

Aplus Finetek Sensor inc.

355 S. Lemon Ave, Suite D, Walnut, CA 91789
 TEL: 1 909 598 2488 FAX: 1 909 598 3188
 Email: peter.wu@aplusfine.com http://www.aplusfine.com



Distributor: