

---

# User Manual M1

Pt100 2-/3-wire -200...850°C / -328...1562°F



## Technical features:

- red display of -1999...9999 digits (optional: green, orange or blue display)
- minimal installation depth: 25 mm without plug-in terminal
- adjustment via factory default or directly on the sensor signal
- min-/max-memory
- displayed in °C / °F
- display flashing at threshold exceedance / undershooting
- impedance matching
- programming interlock via access code
- protection class IP65 at the front
- plug-in terminal
- pc-based configuration software PM-TOOL with CD and USB-adaptor for devices without keypad for a simple adjustment of standard devices

## Identification

STANDARD TYPES	ORDER NUMBER
Pt100 2-/3-wire Housing size: 96x48 mm	<b>M1-1TR4B.030C.570CD</b> <b>M1-1TR4B.030C.770CD</b>

### Options – breakdown of order code:

	M	1-	1	T	R	4	B.	0	3	0	C.	7	7	0	C	D	
<b>Basic type M-Line</b>																	
<b>Installation depth</b> 38 mm incl. plug-in terminal			1														<b>Dimension</b> D physical Unit
<b>Housing size</b> 96x48x25 mm (WxHxD)			1														<b>Version</b> C C
<b>Display type</b> Temperature				T													<b>Switching points</b> 0 no switching point
<b>Display colours</b> Blue Green Red Orange					B G R Y												<b>Protection class</b> 1 without keypad, operation on the back 7 IP65/plug-in terminal
<b>Number of digits</b> 4-digit						4											<b>Supply voltage</b> 5 230 VAC 7 24 VDC galv.insulated
<b>Digit height</b> 14 mm						B											<b>Measuring input</b> C Pt100
<b>Interface</b> without																	<b>Analog output</b> 0 without
																	<b>Pt100 Type</b> 3 2-/3-wire

Please state physical unit by order, e.g. °F.

---

## Content

<b>1. Brief description</b>	<b>2</b>
<b>2. Assembly</b>	<b>2</b>
<b>3. Electrical connection and connection examples</b>	<b>3</b>
<b>4. Function description and operation</b>	<b>4</b>
<b>4.1. Programming software PM-TOOL</b>	<b>4</b>
<b>5. Setting up the device</b>	<b>5</b>
<b>5.1. Switching on</b>	<b>5</b>
<b>5.2. Standard parameterisation (flat operation level)</b>	<b>5</b>
Value assignment for control of the signal input, displayed in °C/°F, impedance matching	
<b>5.3. Programming interlock <i>RUN</i></b>	<b>6</b>
Activation/Deactivation of the programming interlock or change into extended parameterisation	
<b>5.4. Extended parameterisation</b>	<b>6</b>
Superior device functions like e.g.:	
- allocation of functions onto the navigation keys	<b>7</b>
- adjustment of limit values for optical alarm, <i>LI-1/2</i>	<b>7</b>
- safety parameter for locking of the programming, <i>CODE</i>	<b>7</b>
<b>6. Reset to default values</b>	<b>8</b>
Reset of the parameter onto delivery condition	
<b>7. Alarms / Switching points</b>	<b>9</b>
Functional principle of the optical switching points	
<b>8. Technical data</b>	<b>10</b>
<b>9. Safety advice</b>	<b>12</b>
<b>10. Error elimination</b>	<b>13</b>

## 1. Kurzbeschreibung

The panel instrument **M1-1C** is a 4-digit device for Pt100 sensors and a visual limit value monitoring via the display. The configuration happens via three front keys or via the optional PC-software PM-TOOL. An integrated programming interlock prevents unrequested changes of the parameter and can be unlocked again via an individual code.

The electrical connection happens on the rear side via plug-in terminals.

Selectable functions like e.g. the recall of the min/max-value, an impedance matching up to 20°C and a direct change of the limit value in operating mode complete the modern device concept.

## 2. Assembly

Please read the *Safety advice* on page 12 before installation and keep this user manual for future reference.

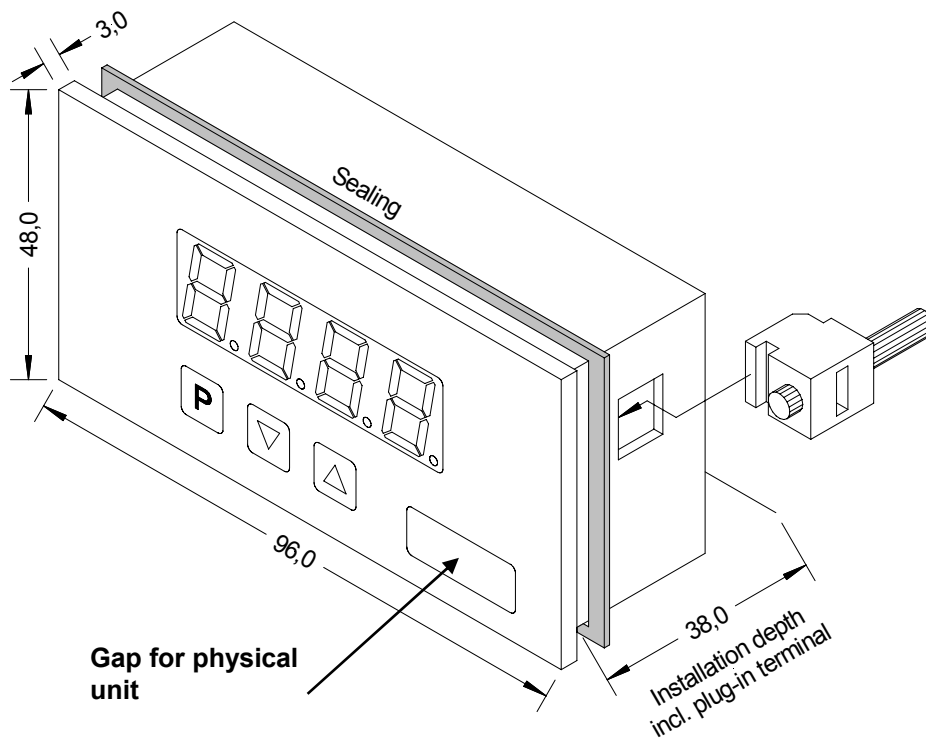

1. After removing the fixing elements, insert the device.
2. Check the seal to make sure it fits securely.
3. Click the fixing elements back into place and tighten the clamping screws by hand. Then use a screwdriver to tighten them another half a turn.

**CAUTION!** The torque should not exceed 0.1 Nm!

### 3. Electrical connection

Type M1-1TR4B.030C.570CD  
supply of 230 VAC

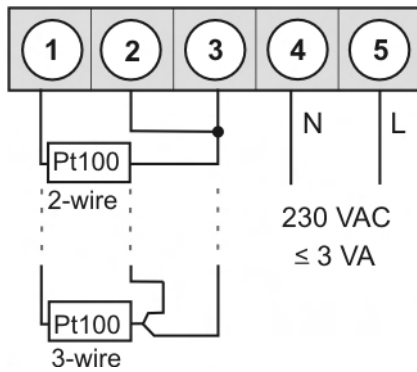

Type M1-1TR4B.030C.770CD  
supply of 24 VDC

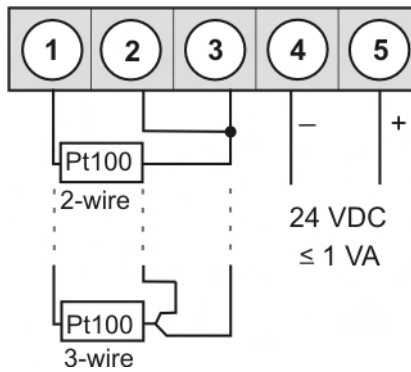

**Advice:**

The galvanic insulation in devices with temperature sensors, that **do not** have a galvanic connection to an extrinsic potential, can be cancelled by a bridge from terminal 3 to 4 and thus stabilise the device against external failures.

Devices with a supply of 230 VAC need to connect terminal 3 to signal ground.

## 4. Function description and operation

### Operation

The operation is divided into two different levels.

### Menu Level







Here it is possible to navigate between the individual menu items.

### Parameterization level:

The parameters stored in the menu item can be parameterized here.

Functions that can be adjusted or changed are always indicated with a flashing of the display. Adjustments made at the parameterization level should be always confirmed by pressing the **[P]** key to save them.

However, the display automatically saves all adjustments and then switches to operation mode if no further keys are pressed within 10 seconds.

Level	Button	Description
Menu level		Change to parameterization level with the relevant parameters
	 	For navigation at the menu level
Parameterization level		To confirm the changes made at the parameterization level
	 	To change the value or setting

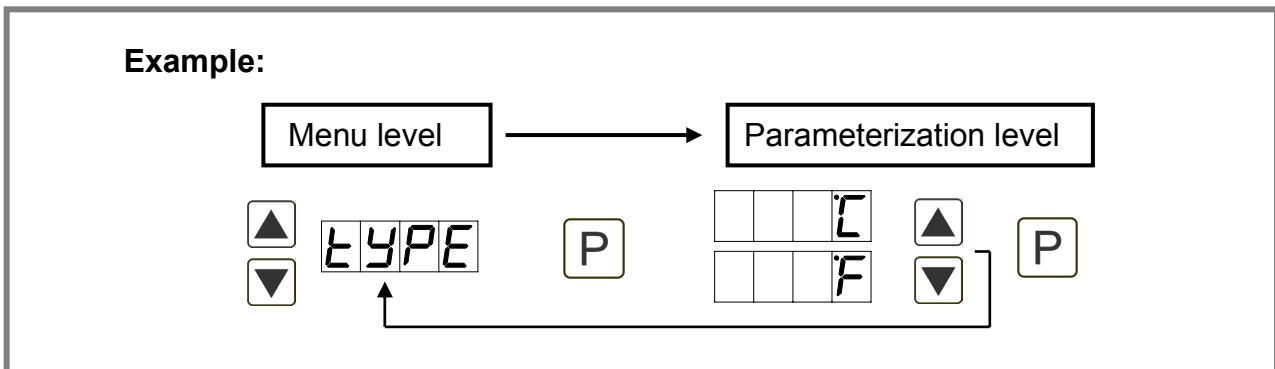

### 4.1. Programming via configuration software PM-TOOL-MUSB4:

You receive the software on CD incl. an USB-cable with a device adapter. The connection is done via a 4-pole micromatch connector plug on the back and the PC is connected via an USB connector plug.

System requirements: PC with USB interface

Software: Windows XP, Windows Vista

With this tool the device configuration can be created, skipped and saved on the PC. Via the easy to handle program surface the parameter can be changed, whereat the mode of operation and the possible selection options can be preset via the program.

## 5. Setting up the device

### 5.1. Switching on

Once the installation is complete, you can start the device by applying the current loop. Check beforehand once again that all the electrical connections are correct.

#### Starting sequence

For 1 second during the switching-on process, the segment test (8 8 8 8 8) is displayed, followed by an indication of the software type and, after that, also for 1 second, the software version. After the start-up sequence, the device switches to operation/display mode.

### 5.2. Standard parameterization:

To be able to parameterize the display, press the [P] key in operating mode for 1 second. The display then changes to the menu level with the first menu item *TYPE*.

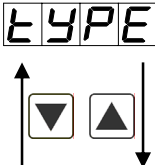
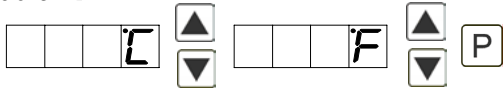
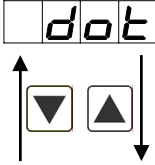
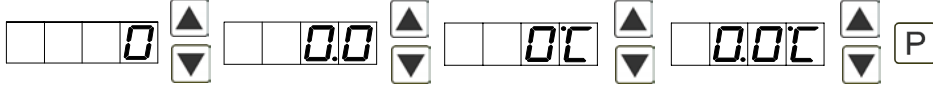
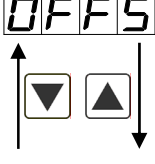
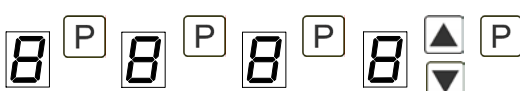
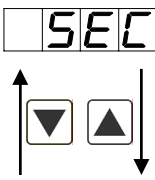
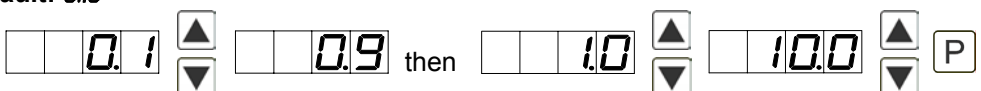
Menu level	Parameterization level
	<p><b>Type of the temperature measurement, <i>TYPE</i>:</b> Default: °C</p>  <p>For representing of temperature choose between °C and °F and confirm with [P]. The display then switches back to the menu level again.</p>
	<p><b>Setting the decimal place / sign of physical unit, <i>END</i>:</b> Default: 000.0</p>  <p>The decimal place and the physical unit are set with [▼] [▲]. If e.g. the temperature measurement is chosen in °C, 0°C or 0.0°C can be selected on the parameterization level. Confirm with [P], the display then switches back to the menu level again.</p>
	<p><b>Impedance matching, <i>OFFS</i>:</b> Default: 0.0</p>  <p>The value for the sensor alignment is adjusted from the smallest to the highest place with [▼] [▲] and confirmed digit per digit with [P]. After the last place the display switches back to the menu level. The value alignment for a temperature measurement in °C can be set between -20.0 and +20.0 and for a measurement in °F between -36.0 and +36.0. If the measurement is redirected later, the value is rounded.</p>
	<p><b>Setting the display time, <i>SEC</i>:</b> Default: 01.0</p>  <p>The display time is set with [▲] [▼]. The display moves up in increments of 0.1 sec up to 1 second and in increments of 1.0 to 10.0 seconds. Confirm the selection by pressing the [P] button. The display then switches back to the menu level again.</p>







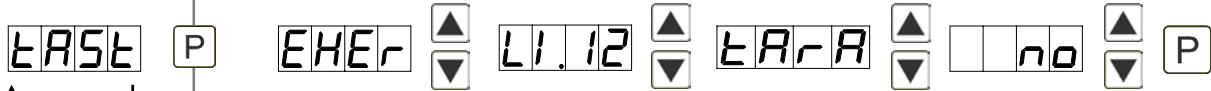
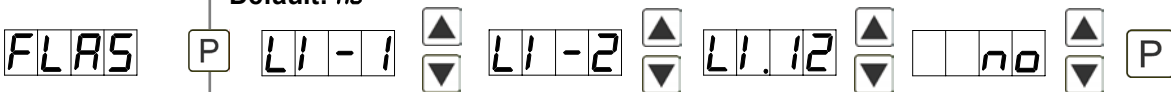

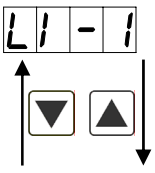

Menu level	Parameterization level
<b>5.3. Programming interlock RUN</b>	
<p><b>Activation / deactivation of the programming lock and completion of the standard parameterization, RUN:</b>                      Default: <i>ULOC</i></p>  <p>With the aid of the [▲] [▼] keys, you can choose between the deactivated key lock <i>ULOC</i> (works setting) and the activated key lock <i>LOC</i>. Make the selection with [P]. After this, the display confirms the settings with "- - -", and automatically switches to operating mode. If <i>LOC</i> was selected, the keyboard is locked. To get back into the menu level, you must press [P] for 3 seconds in operating mode. You must now enter the <i>CODE</i> (works setting 1 2 3 4) that appears using the [▲] [▼] keys plus [P] to unlock the keyboard. <i>FAIL</i> appears if the input is wrong.</p>	

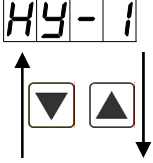

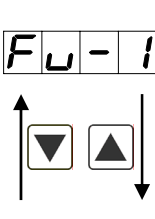
**5.4. Extended parameterization**

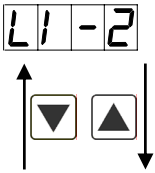
By pressing the [▲] & [▼] buttons during standard parameterization for one second, the display switches to the extended parameterization mode. Operation is the same as in standard parameterization.

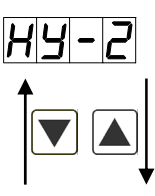
Menu level	Parameterization level
<b>Min/max-value inquiry - Assignment of key functions, TAST:</b> Default: <i>NO</i>	
 <p>Here, you can enter for the operating mode either a min/max-value inquiry or a threshold value correction on the arrow keys.                      If the min/max-memory is activated with <i>EHER</i>, the measured min/max-values will be saved during operation and can be called up via the arrow keys [▲] [▼]. The values are lost if the device is restarted.                      If the threshold value correction <i>LI.1</i> is selected, the limit values can be changed during operation without hindering the operating procedure.                      With <i>TARA</i> the display is tared to zero and is saved permanently as offset. The device confirms the correct taring by showing <i>0000</i> in the display. If <i>NO</i> is parameterized, the navigation keys [▼] [▲] have no function in operating mode.</p>	
<b>Flashing of display, FLAS:</b> Default: <i>NO</i>	
 <p>Here, flashing of the display can be added as an extra alarm function, either to the first limit value (select: <i>LI-1</i>), the second limit value (select: <i>LI-2</i>) or to both limit values (select: <i>LI-12</i>). With <i>NO</i> (works setting), no flashing is assigned at all.</p>	

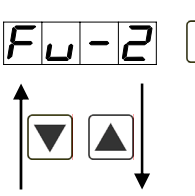

Menu level	Parameterization level
	<p><b>Limit values / Limits, LI-1:</b> Default: 0200</p>  <p>For both limit values, two different values can be parameterized. With this, the parameters for each limit value are called up one after the other.</p>
	<p><b>Hysteresis for limit values, HY-1:</b> Default: 0000</p>  <p>For both limit values, a hysteresis function exists that reacts according to the functional principle (operating current / quiescent current).</p>
	<p><b>Function if display falls below / exceeds limit value, FU-1:</b> Default: HIGH</p>  <p>To indicate if the value falls below the lower limit value, <b>LOW</b> can be selected (LOW = lower limit value) and if it goes above the upper limit value, <b>HIGH</b> can be selected (HIGH = upper limit value). LOW corresponds to the quiescent current principle and HIGH to the operating current principle.</p>
	<p><b>Limit value /Limits, LI-2:</b> Default: 0300</p>  <p>For both limit values, two different values can be parameterized. With this, the parameters for each limit value are called up one after the other.</p>
	<p><b>Hysteresis for limit values, HY-2:</b> Default: 0000</p>  <p>For both limit values, a hysteresis function exists that reacts according to the functional principle (operating current / quiescent current).</p>

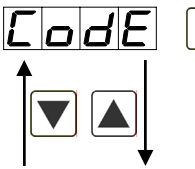
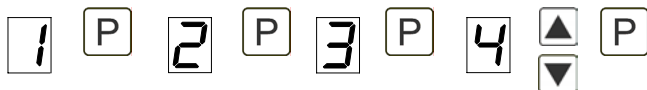
Menu level	Parameterization level
	<p><b>Function if display falls below / exceeds limit value, <i>FU-2</i>:</b>  <b>Default: <i>HIGH</i></b></p>  <p>To indicate if the value falls below the lower limit value, <i>LOW</i> can be selected (LOW = lower limit value) and if it goes above the upper limit value, <i>HIGH</i> can be selected (HIGH = upper limit value). LOW corresponds to the quiescent current principle and HIGH to the operating current principle.</p>
	<p><b>Setting the code, <i>CODE</i>:</b>  <b>Default: <i>1234</i></b></p>  <p>With this setting, it is possible to select an individual code (works setting <i>1 2 3 4</i>) for locking the keyboard. To lock/release the key, proceed according to menu item <i>RUN</i>.</p>

## 6. Reset to default values

To return the unit to a **defined basic state**, a reset can be carried out to the default values.

The following procedure should be used:

- Switch off the power supply
- Press button [P]
- Switch on voltage supply and press [P]-button until „----“ is shown in the display.

With reset, the default values of the program table are loaded and used for subsequent operation. This puts the unit back to the state in which it was supplied.

**Caution! All application-related data are lost.**

## 7. Functional principle of the switching points

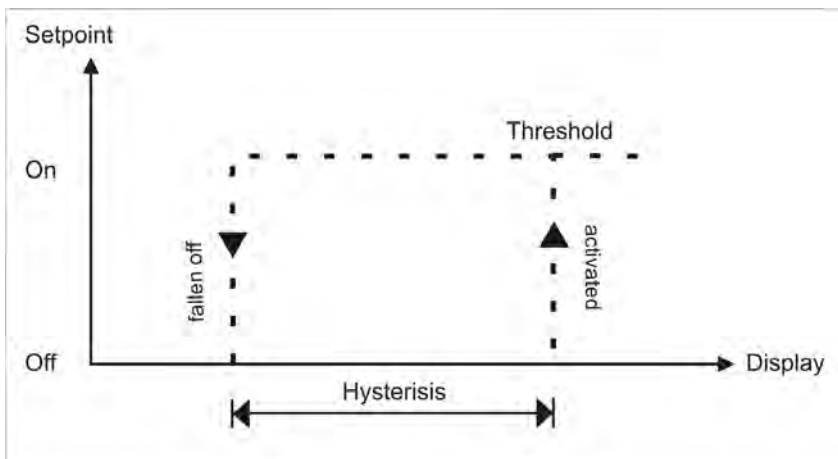

### Limit value exceedance "HIGH"

The switching point S1-S2 is "off" below the threshold and "on" on reaching the threshold.

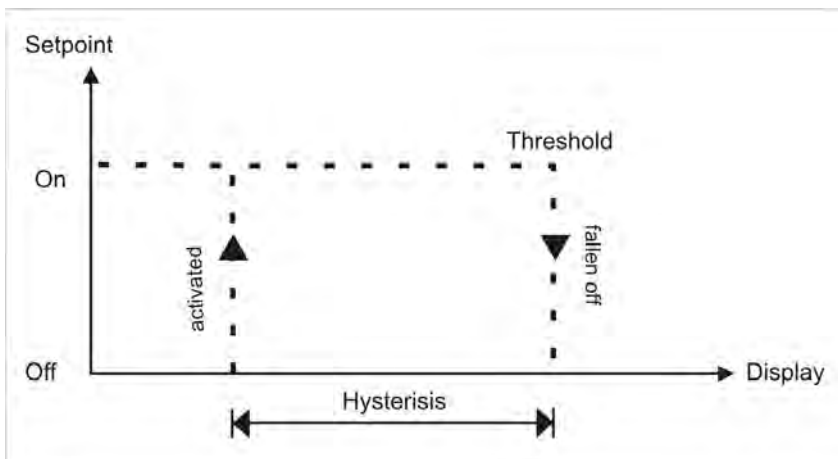

### Limit value undercut "LOW"

The switching point S1-S2 is "on" below the threshold and switched "off" on reaching the threshold.

### Alarms / optical switching point display

An activated set point can be optically indicated by flashing of the 7-segment display.

Functional principle of the alarms	
Alarm	Deactivated, display value
Threshold	Threshold/limit value for switch over
Hysteresis	Width of the window between the thresholds
Operating principle	Limit value exceedance / limit value undercut

## 8. Technical data

<b>Housing</b>			
Dimensions	96x48x25 mm (BxHxD)		
	96x48x38 mm (BxHxD) including plug-in terminal		
Panel cut-out	92.0 <sup>+0.8</sup> x 45.0 <sup>+0.6</sup> mm		
Insulation thickness	up to 3 mm		
Fixing	snap-in screw element		
Material	PC Polycarbonate, black, UL94V-0		
Sealing material	EPDM, 65 Shore, black		
Protection class	standard IP65 (front), IP00 (back side)		
Weight	approx. 100 g		
Connection	plug-in terminal; wire cross section up to 2.5 mm <sup>2</sup>		
<b>Display</b>			
Digit height	14 mm		
Segment colour	red (optional green, orange or blue)		
Display range	-1999 to 9999		
Setpoints	optical display flashing		
Overflow	horizontal bars at the top		
Underflow	horizontal bars at the bottom		
Display time	0.1 to 10.0 seconds		
<b>Input</b>	<b>Measuring range</b>	<b>Measuring fault</b>	<b>Digit</b>
Pt100 2-/3-wire	-200...850°C	0.1 % of measuring range	±1
Pt100 2-/3-wire	-328...1562°F	0.1 % of measuring range	±1
<b>Accuracy</b>			
Temperature drift	100 ppm / K		
Measuring time	0.1...10.0 seconds		
Measuring principle	U/F-conversion		
Resolution	0.1°C or 0.1°F		
Power pack	230 VAC ±10 % max. 3 VA 24 VDC ±10 % max. 1 VA		
<b>Memory</b>	EEPROM		
Data life	≥ 100 years at 25°C		

<b>Ambient conditions</b>	
Working temperature	0°C...60°C
Storing temperature	-20°C...80°C
Weathering resistance	relative humidity 0-80% on years average without dew
<b>EMV</b>	
	EN 61326
<b>CE-sign</b>	
	Conformity to directive 2004/108/EG
<b>Safety standard</b>	
	According to low voltage directive 2006/95/EG EN 61010; EN 60664-1

## 9. Safety advice

Please read the following safety advice and the assembly *chapter 2* before installation and keep it for future reference.

### Proper use

The **M1-1C-device** is designed for the evaluation and display of Pt100 signals.



**Danger!** Careless use or improper operation can result in personal injury and/or damage to the equipment.

### Control of the device

The panel meters are checked before dispatch and sent out in perfect condition. Should there be any visible damage, we recommend close examination of the packaging. Please inform the supplier immediately of any damage.



### Installation

The **M1-1C-device** must be installed by a suitably **qualified specialist** (e.g. with a qualification in industrial electronics).

### Notes on installation

- There must be no magnetic or electric fields in the vicinity of the device, e.g. due to transformers, mobile phones or electrostatic discharge.
- The **fuse rating** of the supply voltage should not exceed a value of **6A N.B. fuse**.
- Do not install **inductive consumers** (relays, solenoid valves etc.) near the device and **suppress** any interference with the aid of RC spark extinguishing combinations or free-wheeling diodes.
- Keep input, output and supply lines separate from each other and do not lay them parallel with each other. Position “go” and “return lines” next to one another. Where possible use twisted pair. So, the best measuring results can be received.
- Screen off and twist sensor lines. Do not lay current-carrying lines in the vicinity. Connect the **screening on one side** on a suitable potential equaliser (normally signal ground).
- The device is not suitable for installation in areas where there is a risk of explosion.
- Any electrical connection deviating from the connection diagram can endanger human life and/or can destroy the equipment.
- The terminal area of the devices is part of the service. Here electrostatic discharge needs to be avoided. Attention! High voltages can cause dangerous body currents.
- Galvanic insulated potentials within one complex need to be placed on an appropriate point (normally earth or machines ground). So, a lower disturbance sensibility against impacted energy can be reached and dangerous potentials, that can occur on long lines or due to faulty wiring, can be avoided.

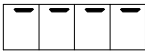
## 10. Error elimination

	Error description	Measures
1.	The unit permanently indicates overflow. 	<ul style="list-style-type: none"> <li>• The input has a very high measurement, check the measuring circuit.</li> <li>• The input is open.</li> </ul>
2.	The unit permanently shows underflow. 	<ul style="list-style-type: none"> <li>• The input has a very low measurement, check the measuring circuit .</li> <li>• The input is open.</li> </ul>
3.	The word " <b>HELP</b> " lights up in the 7-segment display.	<ul style="list-style-type: none"> <li>• The unit has found an error in the configuration memory. Perform a reset on the default values and re-configure the unit according to your application.</li> </ul>
4.	Program numbers for parameterising of the input are not accessible.	<ul style="list-style-type: none"> <li>• Programming lock is activated</li> <li>• Enter correct code</li> </ul>
5.	" <b>ERRT</b> " lights up in the 7-segment display	<ul style="list-style-type: none"> <li>• Please contact the manufacturer if errors of this kind occur.</li> </ul>
6.	The device does not react as expected.	<ul style="list-style-type: none"> <li>• If you are not sure if the device has been parameterised before, then follow the steps as written in <i>chapter 6</i> and set it back to its delivery status.</li> </ul>
7.	The temperature value is unstable.	<ul style="list-style-type: none"> <li>• Please check the possibility to set aside the galvanic insulation for a discharging of failures as described under <i>chapter 3</i> „Electrical connection“. Before make sure that the possible metal sensor is separated from the sensor element.</li> </ul>

