

---

# User manual M2

## DMS amplifier with taring for 350 $\Omega$ melt pressure sensors



### Technical features:

- red display of -19999...99999 Digits (optional: green, orange or blue display)
- minimal installation depth: 70 mm without plug-in screw terminal
- min-/max-memory
- 30 additional adjustable supporting points
- display flashing at threshold value exceedance / threshold value undercut
- zero-key for triggering of Hold, Tara or sensor alignment
- digital input for triggering of Hold, Tara or sensor alignment
- permanent min/max-value recording
- mathematic functions like reciprocal value, square root, squaring or rounding
- sliding average determination
- brightness control
- programming interlock via access code
- protection class IP65 at the front side
- plug-in screw terminal
- optional: 2 relay outputs
- accessories: PC-based configuration-kit PM-TOOL with CD & USB-adapter for devices without keypad and for a simple adjustment of standard devices

## Identification

STANDARD TYPES	ORDER NUMBER
Weighing technology	<b>M2-1WR5B.020X.672CD</b>
Housing size: 96x48 mm	<b>M2-1WR5B.020X.670CD</b>

Options – breakdown product key:

	M	2	-	1	W	R	5	B.	0	2	0	X.	6	7	2	C	D		
<b>Standard type M-line</b>																			<b>Dimension</b>
																			<input type="checkbox"/> D physical unit
<b>Installation depth</b> 89 mm, incl. plug-in terminal																			<b>Version</b>
																			<input type="checkbox"/> C C
<b>Housing size</b> 96x48x70 mm (BxHxD)																			<b>Switching points</b>
																			<input type="checkbox"/> 0 no switching points
																			<input type="checkbox"/> 2 2 relay outputs
<b>Display type</b> Weighing technology																			<b>Protection class</b>
																			<input type="checkbox"/> 1 without keypad, operation at the back
<b>Display colour</b> Blue Green Red Yellow																			<input type="checkbox"/> 7 IP65 / plug-in terminal
																			<b>Supply voltage</b>
																			<input type="checkbox"/> 4 115 VAC
																			<input type="checkbox"/> 5 230 VAC
																			<input type="checkbox"/> 6 10-30 VDC galv. insulated
<b>Number of digits</b> 5-digit																			<b>Measuring input</b>
																			<input type="checkbox"/> X Weighing technology 1 - 3,3 mV
<b>Digit height</b> 14 mm																			<b>Analog output</b>
																			<input type="checkbox"/> 0 without
<b>Digital input</b> Standard																			<b>Bridge feeding</b>
																			<input type="checkbox"/> 2 10 VDC / 20-40 mA incl. digital input

Please state physical unit by order, e.g. kg

---

## Contents

<b>1. Brief description</b>	<b>2</b>
<b>2. Assembly</b>	<b>3</b>
<b>3. Electrical connection</b>	<b>4</b>
<b>4. Functions and operation description</b>	<b>6</b>
<b>4.1. Programming software PM-TOOL</b>	<b>7</b>
<b>5. Setting up the device</b>	<b>8</b>
<b>5.1. Switching on</b>	<b>8</b>
<b>5.2. Standard parameterisation (flat operation level)</b>	<b>8</b>
Value assignment for triggering of the signal input	
<b>5.3. Programming interlock „RUN“</b>	<b>11</b>
Activation/Deactivation of the programming interlock or change into the professional level respectively back into the flat operation level	
<b>5.4. Extended parameterisation (professional operation level)</b>	<b>12</b>
<b>5.4.1. Signal input parameter „INP“</b>	<b>12</b>
Value assignment for triggering of the signal input incl. linearisation	
<b>5.4.2. General device parameter „FCT“</b>	<b>15</b>
Higher device functions like Hold, Tara, min/max permanent, average determination, brightness control, as well as the control of the digital input and the keyboard configuration	
<b>5.4.3. Safety parameter „COD“</b>	<b>18</b>
Assignment of user and master code for locking or access to certain parameters like e.g. analog output and alarms, etc.	
<b>5.4.4. Relay functions „REL“</b>	<b>19</b>
Parameter for the definition of the setpoints	
<b>5.4.5. Alarm parameter „ALI...ALY“</b>	<b>21</b>
Activator and dependencies of the alarms	
<b>6. Reset to factory settings</b>	<b>22</b>
Reset of the parameter to the factory default settings	
<b>7. Alarms / Relays</b>	<b>23</b>
Function principle of the switching outputs	
<b>8. Sensor alignment</b>	<b>24</b>
Function diagram for sensors with existing trimming resistor	
<b>9. Technical data</b>	<b>25</b>
<b>10. Safety advices</b>	<b>27</b>
<b>11. Error elimination</b>	<b>28</b>

## 1. Brief description

The panel meter **M2-1W** is a 5-digit device for connection to a 4-wire-measuring bridge and a visual threshold value monitoring via the display. The configuration happens via four front keys or via the optional PC software PM-TOOL. An integrated programming interlock prevents unrequested changes of the parameters and can be unlocked again by an individual code. Optional the following functions are available: a 10 V bridge feeding, a digital input for the triggering of Hold or Tara and two optional galvanic insulated setpoints, by which free adjustable threshold values can be controlled and reported to a superior master display.

The electrical connection is carried out on the back side via plug-in terminals.

Selectable functions like e.g. the request of the min/max-value, an average determination of the measuring signals, a direct change of threshold value in operation mode and additional measuring supporting points for linearisation complete the modern device concept.

## 2. Assembly

Please read the *Safety advices* on page 27 before installation and keep this user manual for future reference.

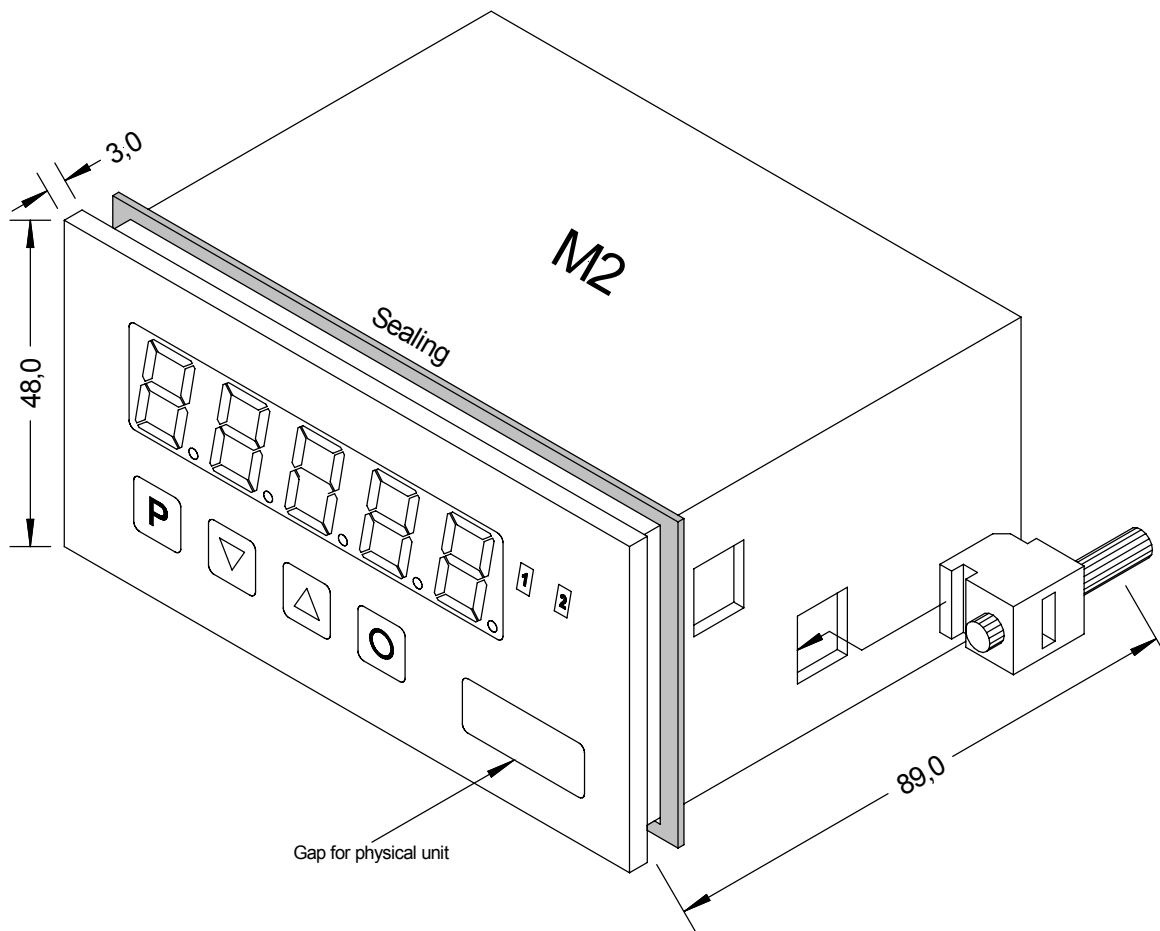

1. After removing the fixing elements, insert the device.
2. Check the seal to make sure it fits securely.
3. Click the fixing elements back into place and tighten the clamping screws by hand. Then use a screwdriver to tighten them another half a turn.

**CAUTION!** The torque should not exceed 0.1 Nm!

The dimension symbols can be exchanged before installation via a channel on the side!

### 3. Electrical connection

Type M2-1WR5B.020X.470CD with a supply of 115 VAC

Type M2-1WR5B.020X.570CD with a supply of 230 VAC

Type M2-1WR5B.020X.670CD with a supply of 10-30 VDC

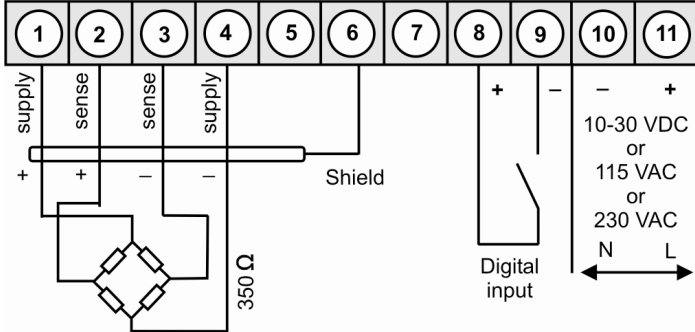

Options:

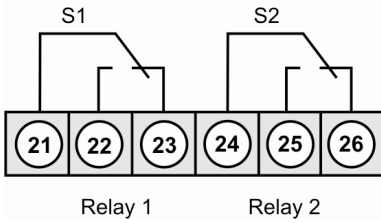

## 4. Function and operation description

### Operation

The operation is divided into three different levels.

#### Menu level (delivery status)













This level is for the standard settings of the device. Only menu items which are sufficient to set the device into operation are displayed. To get into the professional level, run through the menu level and parameterise "PROF" under menu item *RUN*.

#### Menu group level (complete function volume)

Suited for complex applications as e.g. linkage of alarms, setpoint treatment, totaliser function etc. In this level function groups which allow an extended parameterisation of the standard settings are available. To leave the menu group level, run through this level and parameterise „ULOC,, under menu item *RUN*.

#### Parameterisation level:

Parameter deposited in the menu item can here be parameterised. Functions, that can be changed or adjusted, are always signalled by a flashing of the display. Settings that are made in the parameterisation level are confirmed with [P] and thus saved. By pressing the [O]-key (zero-key) it leads to a break-off of the value input and to a change into the menu level. All adjustments are saved automatically by the device and it changes into operating mode, if no further key operation is done within the next 10 seconds.

Level	Key	Description
Menu level		Change to parameterisation level and deposited values.
	 	Keys for up and down navigation in the menu level.
		Change into operation mode.
Parameterisation level		To confirm the changes made at the parameterization level.
	 	Adjustment of the value / the setting.
		Change into menu level or break-off in value input.
Menu group level		Change to menu level.
	 	Keys for up and down navigation in the menu group level.
		Change into operation mode or back into menu level.

**Function chart:**

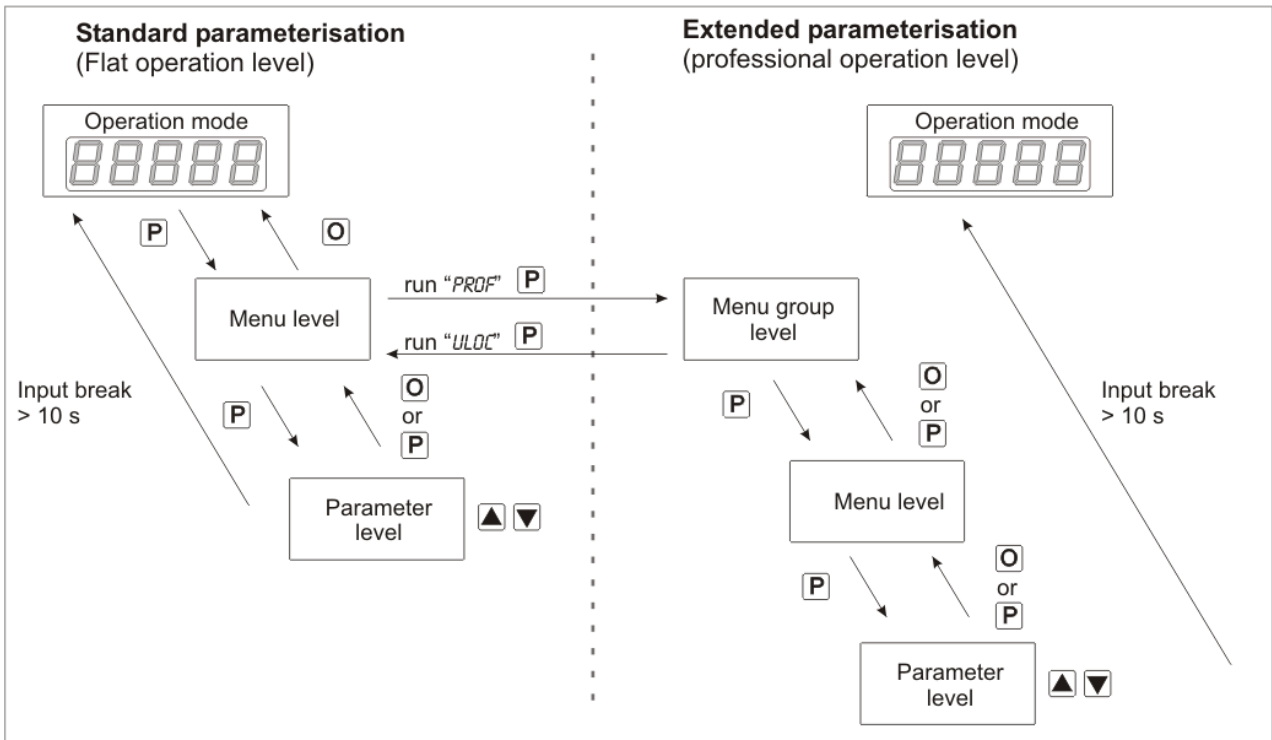

**Underline:**

- P** Takeover
- O** Stop
- ▲** Value selection (+)
- ▼** Value selection (-)

**4.1 Parameterisation software PM-TOOL:**

Part of the PM-TOOL are the software on CD and an USB-cable with device adapter. The connection is done via a 4-pole micromatch-plug on the back side of the device, to the PC-side the connection ist done via an USB plug.

System requirements: PC incl. USB interface  
 Software: Windows XP, Windows VISTA

With this tool the device configuration can be generated, omitted and safed on the PC. The parameters can be changed via the easy to handle program surface, whereat the operating mode and the possible selection options can be preset by the program.



## 5. Setting up the device

### 5.1. Switching-on





Once the installation is complete, you can start the device by applying the voltage supply. First, check once again that all electrical connections are correct.



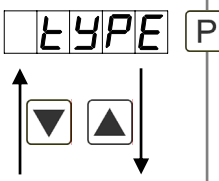
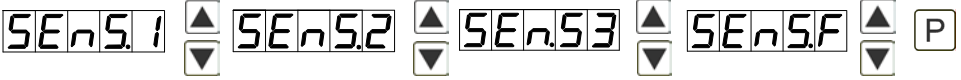
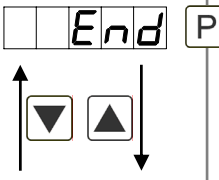

#### Starting sequence

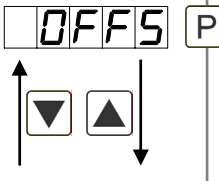



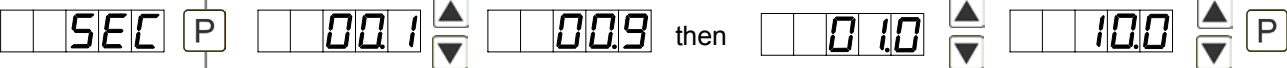

For 1 second during the switching-on process, the segment test (8 8 8 8 8) is displayed followed by an indication of the software type and, after that, also for 1 second the software version. After the starting sequence, the device switches to operation/display mode.

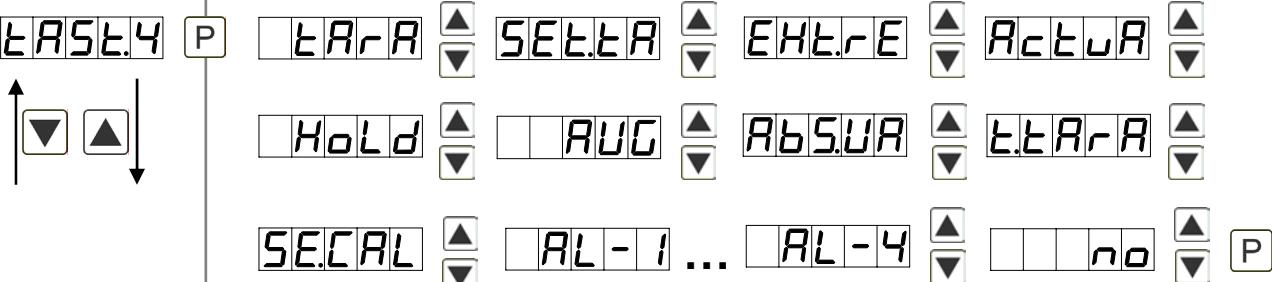

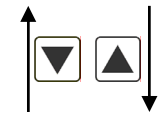
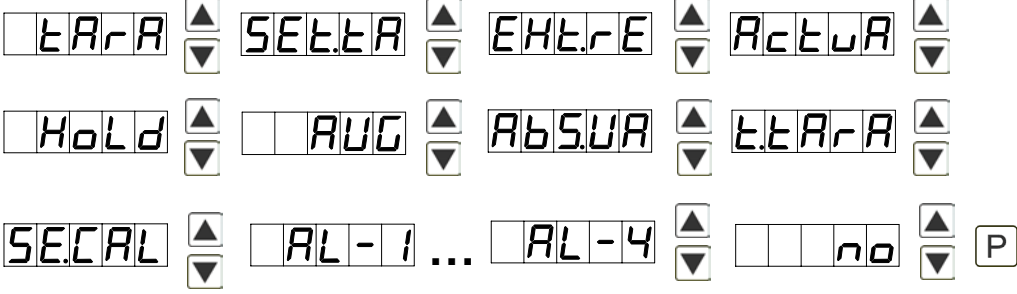

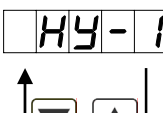

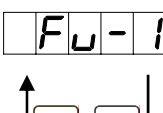
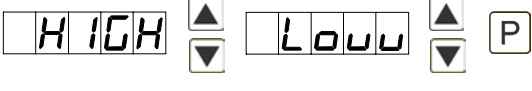

### 5.2. Standard parameterisation: (Flat operation level)

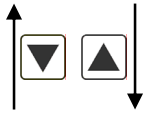
To parameterise the display, press the [P] key in operating mode for 1 second. The display then changes to the menu level with the first menu item *TYPE*.

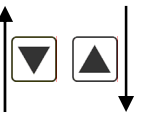
Menu level	Parameterisation level
	<p><b>Selection of the input signal, <i>TYPE</i>:</b> Default: <i>SENS.F</i></p>  <p>There are 3 measuring input options available for known sensor sensibilities: <i>SENS.1</i> for 1mV/V, <i>SENS.2</i> for 2mV/V and <i>SENS.3</i> for 3,3mV/V. Each sensor is measured and calibrated up to 4mV/V via <i>SENS.F</i>. Confirm the selection with [P] and the display switches back to menu level.</p>
	<p><b>Setting the measuring range end value, <i>END</i>:</b> Default: <i>10000</i></p>  <p>Set the end value from the smallest to the highest digit with [▲] [▼] and confirm each digit with [P]. A minus sign can only be parameterized on the highest value digit. After the last digit, the display switches back to the menu level. If <i>SENS</i> was selected as input option, you can only select between <i>NOCA</i> and <i>CAL</i>. With <i>NOCA</i>, only the previously set display value is taken over, and with <i>CAL</i>, the device takes over both the display value and the analogue input value.</p>
	<p><b>Setting up the measuring range start/offset value, <i>OFFS</i>:</b> Default: <i>0</i></p>  <p>Enter the start/offset value from the smallest to the highest digit with [▲] [▼] and confirm each digit with [P]. After the last digit the display switches back to the menu level. If <i>SENS</i> was selected as input option, you can only select between <i>NOCA</i> and <i>CAL</i>. With <i>NOCA</i>, only the previously set display value is taken over, and with <i>CAL</i>, the device takes over both the display value and the analogue input value.</p>

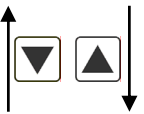
Menu level	Parameterisation level
	<p><b>Setting the comma, decimal point, DOT :</b> Default: 0</p> <p>  </p> <p>The decimal point on the display can be moved with [▲] [▼] and confirmed with [P]. The display then switches back to the menu level again.</p>
	<p><b>Setting up the display time, SEC :</b> Default: 1.0</p> <p>  </p> <p>The display time is set with [▲] [▼]. The display moves up in increments of 0.1 up to 1 second and in increments of 1.0 up to 10.0 seconds. Confirm the selection by pressing the [P] button. The display then switches back to the menu level again.</p>
	<p><b>Special function [O]-key, TAST.4:</b> Default: NO</p> <p>  </p> <p>For the operation mode, special functions can be deposited on the [O]-Taste. This function is activated by pressing the key. With <b>TARA</b> the display is tared to zero und safed permanently as Offset. The device acknowledges the correct taring with <b>00000</b> in the display. <b>SET.TA</b> switches into the Offset value and can thus be changed via the navigation keys [▲] &amp; [▼]. <b>EHT.RE</b> deletes the min/max memory. <b>ACTUA</b> shows the measurand, then the display changes onto the parameterised display value. The same goes for <b>AVG</b>, here the sliding average value is displayed. If <b>HOLD</b> has been selected, the moment can be hold constant by pressing the [O]-key, and is updated by releasing the key. <b>Advice:</b> <b>HOLD</b> is activated only, if <b>HOLD</b> is selected under parameter <b>DISPL</b>. If <b>ABS.UA</b> (absolute value) was selected, the display shows the values that have been measured since the voltage has been connected, without consideration of a previous taring. With <b>T.TARA</b> (temporarily Tara) the offset is determined by rising shoulder of the digital input and kept only for the period of the signal. Via <b>SE.CAL</b> a sensor calibration is done by pushing the zero-key, the flow diagram is shown in <i>chapter 4.4</i>. At <b>AL-1...AL-8</b> an output can be set and therewith e.g. a switch of the metering point can be done. If <b>NO</b> is selected, the [O]-key is without any function in the operation mode.</p>

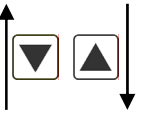
Menu level	Parameterisation level
	<p><b>Special function digital input, DIG.IN:</b> Default: <i>SE.CAL</i></p> <p>  </p> <p>The above given parameters can be set for the operation mode onto the optional digital input aswell. See function description <i>TAST.4</i>.</p>
	<p><b>Threshold values / Limit values, LI-1:</b> Default: <i>2000</i></p> <p>  </p> <p>This limit value defines the threshold, that leads to an activation / deactivation of the alarm.</p>
	<p><b>Hysteresis for limit values, HY-1:</b> Default: <i>0</i></p> <p>  </p> <p>The difference to the threshold value that causes the delay of the actuation of the alarm, is defined by the hysteresis.</p>
	<p><b>Function if display falls below / exceeds limit value, FU-1:</b> Default: <i>HIGH</i></p> <p>  </p> <p>The limit value undercut can be selected with <i>LOWU</i> (LOW = lower limit value) and limit value exceedance can be selected with <i>HIGH</i> (HIGH = upper limit value). If e.g. limit value 1 is on a switching threshold of 100 and occupied with function <i>HIGH</i>, the alarm will be activated by reaching the threshold. If the limit value is allocated to <i>LOWU</i>, an alarm will be activated by undercut of the threshold.</p>
	<p><b>Threshold values / Limit values, LI-2:</b> Default: <i>3000</i></p> <p>  </p> <p>This limit value defines the threshold, that leads to an activation / deactivation of the alarm.</p>

Menu level	Parameterisation level
	<p><b>Hysteresis for threshold values, HY-2:</b> Default: 0</p> <p>  </p> <p>The difference to the threshold value that causes the delay of the actuation of the alarm, is defined by the hysteresis.</p>
	<p><b>Function if display falls below / exceeds limit value, FU-2</b> Default: HIGH</p> <p>  </p> <p>The limit value undercut can be selected with <b>LOW</b> (LOW = lower limit value) and limit value exceedance can be selected with <b>HIGH</b> (HIGH = upper limit value). If e.g. limit value 1 is on a switching threshold of 100 and occupied with function <b>HIGH</b>, the alarm will be activated by reaching the threshold. If the limit value is allocated to <b>LOW</b>, an alarm will be activated by undercut of the threshold.</p>
	<p><b>User code (4-digit number-combination, free available), U.CODE:</b> Default: 0000</p> <p>  </p> <p>If this code is set (&gt;0000), all parameters are locked for the user, if <b>LOC</b> has been selected under menu item <b>RUN</b>. By pressing <b>[P]</b> for approx. 3 seconds in operation mode, the message <b>CODE</b> is shown in the display. Enter the preset <b>U.CODE</b> to get access to the for the user unlocked set of parameters. The code needs to be entered bevor each try of parameterisation, as long as <b>R.CODE</b> (Master code) all parameters are unlocked again.</p>
	<p><b>Master code (4-digit number-combination free available), R.CODE:</b> Default: 1234</p> <p>  </p> <p>After <b>LOC</b> has been activated under menu item <b>RUN</b>, this code can be used for unlocking all parameters. By pressing <b>[P]</b> for approx. 3 seconds in operation mode, the message <b>CODE</b> is shown in the display and offer the user access to all parameters by entering <b>R.CODE</b>. While leaving this parameterisation it can be unlocked permanently under <b>RUN</b> by selecting <b>ULOC</b> or <b>PROF</b>. So, at an anew pressing of <b>[P]</b> in operating mode, an anew entereing of the code is not needed.</p>

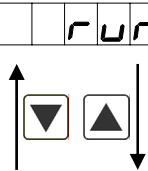
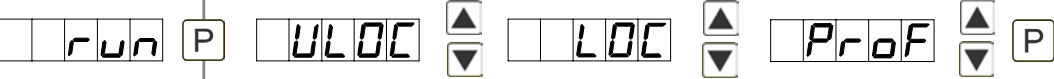





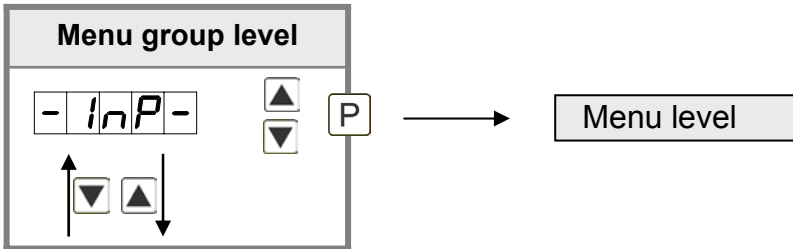



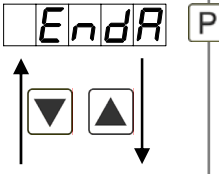

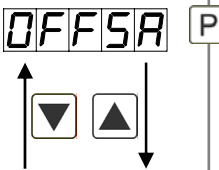
Menu level	Parameterisation level
<b>5.3. Programming interlock</b>	
	<p data-bbox="347 383 1481 479"><b>Activation / Deactivation of the programming interlock or completion of the standard parameterisation with change into menu group level (complete function volume), <i>RUN</i>:</b> Default: <i>ULOC</i></p> <div data-bbox="129 517 1187 595">  </div> <p data-bbox="347 640 1481 831">With the navigation keys [▲] [▼], one can choose between the deactivated key lock <i>ULOC</i> (works setting), the activated key lock <i>LOC</i>, or the menu group level <i>PROF</i>. Confirm the selection with [P]. After this, the display confirms the settings with "- - - -", and automatically switches to operating mode. If <i>LOC</i> was selected, the keyboard is locked. To get back into the menu level, press [P] for 3 seconds in operating mode. Now enter the <i>CODE</i> (works setting <i>1234</i>) that appears using [▲] [▼] plus [P] to unlock the keyboard. <i>FAIL</i> appears if the input is wrong.</p> <p data-bbox="347 842 1481 990">To parameterise further functions, <i>PROF</i> needs to be set. The device confirms this setting with „- - - -“, and changes automatically into operation mode. By pressing [P] for approx. 3 seconds in operation mode, the first menu group <i>INP</i> is shown in the display and thus confirms the change into the extended parameterisation. It stays as long activated as <i>ULOC</i> is entered in menu group <i>RUN</i>, thus the display is set back in standard parameterisation again.</p>

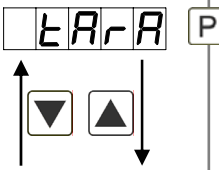

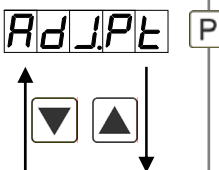

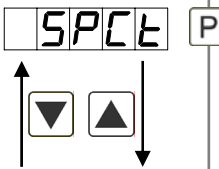

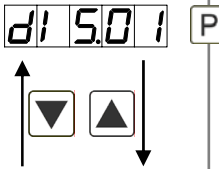
**5.4. Extended parameterisation** (Professional operation level)

**5.4.1. Signal input parameters**

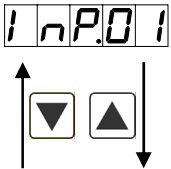

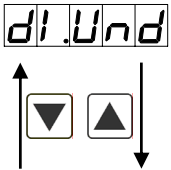
Menu level	Parameterisation level
	<p><b>Selection of the input signal, TYPE:</b> Default: <i>SENS.F</i></p> <p>TYPE P SENS.1 SENS.2 SENS.3 SENS.F P</p> <p>There are 3 measuring input options available for known sensor sensibilities: <i>SENS.1</i> for 1mV/V, <i>SENS.2</i> for 2mV/V and <i>SENS.3</i> for 3,3mV/V. Each sensor is measured and calibrated up to 4mV/V via <i>SENS.F</i>. Confirm the selection with [P] and the display switches back to menu level.</p>
	<p><b>Setting the measuring range end value, END:</b> Default: <i>10000</i></p> <p>End P 8 P 8 P 8 P 8 P 8   nOCA P CAL P</p> <p>Set the end value from the smallest to the highest digit with [▲] [▼] and confirm each digit with [P]. A minus sign can only be parameterized on the highest value digit. After the last digit, the display switches back to the menu level. If <i>SENS</i> was selected as input option, you can only select between <i>nOCA</i> and <i>CAL</i>. With <i>nOCA</i>, only the previously set display value is taken over, and with <i>CAL</i>, the device takes over both the display value and the analogue input value.</p>
	<p><b>Setting up the measuring range start/offset value, OFFS:</b> Default: <i>0</i></p> <p>OFFS P 8 P 8 P 8 P 8 P 8   nOCA P CAL P</p> <p>Enter the start/offset value from the smallest to the highest digit with [▲] [▼] and confirm each digit with [P]. After the last digit the display switches back to the menu level. If <i>SENS</i> was selected as input option, you can only select between <i>nOCA</i> and <i>CAL</i>. With <i>nOCA</i>, only the previously set display value is taken over, and with <i>CAL</i>, the device takes over both the display value and the analogue input value.</p>
	<p><b>Setting up the display time, SEC:</b> Default: <i>1.0</i></p> <p>SEC P 00.1 00.9 then 0.10 10.0 P</p> <p>The display time is set with [▲] [▼]. The display moves up in increments of 0.1 sec up to 1 sec and in increments of 1.0 sec up to 10.0 sec. Confirm the selection by pressing the [P] button. The display then switches back to the menu level again.</p>

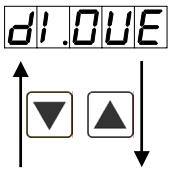
Menu level	Parameterisation level
	<p><b>Rescaling the measuring input values, <i>ENDA</i>:</b> Default: 10000</p>  <p>With this function, you can rescale the input value of e.g. 1.1 mV (works setting) without applying a measuring signal.</p>
	<p><b>Rescaling the measuring input values, <i>OFFSA</i>:</b> Default: 0</p>  <p>With this function, you can rescale the input value of e.g. 0.1 mV (works setting) without applying a measuring signal.</p>
	<p><b>Setting up the tare/offset value, <i>TARR</i>:</b> Default: 0</p>  <p>The given value is added to the linearized value. In this way, the characteristic line can be shifted by the selected amount.</p>
	<p><b>Setting up the balance point, <i>ADJ.PT</i>:</b> Default: 100.00</p>  <p>The balance point for the final value can be selected here in % by the measuring range <i>SENS.F</i>.</p>
	<p><b>Number of additional setpoints, <i>SPCT</i>:</b> Default: 00</p>  <p>30 additional setpoints can be defined to the initial- and final value, so linear sensor values are not linearised. Only activated setpoint parameters are displayed.</p>
	<p><b>Display values for setpoints, <i>DIS.01 ... DIS.30</i>:</b></p>  <p>Under this parameter setpoints are defined according to their value. At the sensor calibration, like at Endwert/Offset, one is asked at the end if a calibration shall be activated.</p>

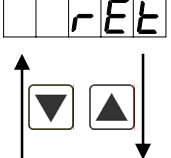
Menu level	Parameterisation level
	<p><b>Analog values for setpoints, INP.01 ... INP.30:</b></p>  <p>The setpoints are always preset according to the selected input signal mA/V. The demanded analog values can be freely adjusted in ascending order.</p>
	<p><b>Device undercut, DI.UND:</b> Default: -9999</p>  <p>With this function the device undercut (_____) can be defined on a definite value. Exception is input type <b>4-20 mA</b>, it already shows undercut at a signal &lt;1 mA, so a sensor failure is marked.</p>
	<p><b>Display overflow, DI.OUE:</b> Default: 9999</p>  <p>With this function the display overflow (-----) can be defined on a definite value.</p>
	<p><b>Back to menu group level, RET:</b></p> <p>With <b>[P]</b> the selection is confirmed and the device changes into menu group level „-INP-“.</p>



5.4.2. General device parameters

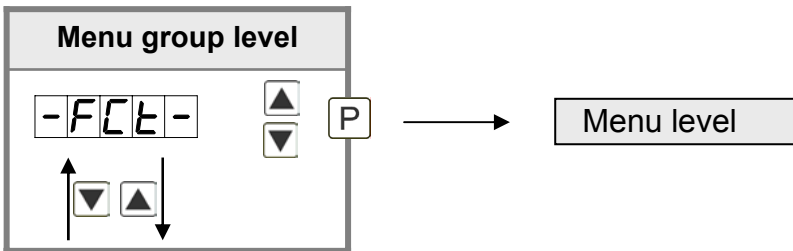

Menu level	Parameterisation level
	<p><b>Display time, <i>DISC</i>:</b> Default: 01.0</p> <p>The display time is set up with [▲] [▼]. Thereby you switch up to 1 second in increments of 0.1 and up to 10.0 seconds in increments of 1.0. With [P] the selection is confirmed and the device changes into menu level.</p>
	<p><b>Rounding of display values, <i>ROUND</i>:</b> Default: 00001</p> <p>This function is for instable display values, where the display value is changed in 1-, 5-, 10- or 50-steps. This does not affect the resolution of the optional outputs. With [P] the selection is confirmed and the device changes into menu level.</p>
	<p><b>Arithmetics, <i>ARITH</i>:</b> Default: NO</p> <p>With this function the calculated value, not the measuring value, is shown in the display. With <b>NO</b>, no calculation is deposited. With [P] the selection is confirmed and the device changes into menu level.</p>
	<p><b>Sliding average determination, <i>AVG</i>:</b> Default: 10</p> <p>Under this menu item, the number of measurements that need to be averaged are preset. The averaging time results from the product of measuring time <b>SEC</b> and the averaged measurements <b>AVG</b>. With selection of <b>AVG</b> in menu level <b>DISPL</b> the result is shown in the display and evaluated when entered in the alarm <b>ALT-AL4</b>.</p>
	<p><b>Zero point slowdown, <i>ZERO</i>:</b> Default: 00</p> <p>At the zero point slowdown, a value range around the zero point can be preset, so the display shows a zero. If e.g.10 is set, the display would show a zero in the value range from -10 to +10; below continue with -11 and beyond with +11. The maximum adjustable range of value is 99.</p>

Menu level	Parameterisation level
<p><b>DISPL</b> P</p> <p>▲ ▼</p>	<p><b>Display, DISPL:</b> Default: <i>ACTUA</i></p> <p>ABSUA ▲ ▼    ACTUA ▲ ▼    MINUA ▲ ▼    MAXUA ▲ ▼</p> <p>    HOLD ▲ ▼        AUG ▲ ▼ P</p> <p>With this function the current measuring value, the min-value/max-value, the totaliser, the process-controlled hold-value, the sliding average value, the constant value or the difference between constant value and current value can be allocated to the display. With [P] the selection is confirmed and the device changes into menu level.</p>
<p><b>LIGHT</b> P</p> <p>▲ ▼</p>	<p><b>Brightness control, LIGHT:</b> Default: <i>15</i></p> <p>    00 ▲ ▼        15 ▲ ▼ P</p> <p>The brightness of the display can be adjusted in 16 levels from 00 = very dark to 15 = very bright via this parameter or alternatively via the navigation keys from the outside. During the start of the device the level that is deposited under this parameter will always be used, even though the brightness has been changed via the navigation keys in the meantime.</p>
<p><b>FLASH</b> P</p> <p>▲ ▼</p>	<p><b>Display flashing, FLASH:</b> Default: <i>NO</i></p> <p>    no ▲ ▼    AL-1 ▲ ▼    AL-2 ▲ ▼    AL.12 ▲ ▼</p> <p>    AL-3 ▲ ▼    AL-4 ▲ ▼    AL.34 ▲ ▼    AL.AL ▲ ▼ P</p> <p>A display flashing can be added as additional alarm function either to single or to a combination of off-limit condition. With <i>NO</i>, no flashing is allocated.</p>
<p><b>TAST</b> P</p> <p>▲ ▼</p>	<p><b>Assignment (deposit) of key functions, TAST:</b> Default: <i>NO</i></p> <p>    EHTR ▲ ▼    LI.12 ▲ ▼    LI.34 ▲ ▼    TARAR ▲ ▼</p> <p>    SETTA ▲ ▼    EHT.RE ▲ ▼    ACTUA ▲ ▼    ABSUA ▲ ▼</p> <p>    LIGHT ▲ ▼        no ▲ ▼ P</p> <p>For the operation mode, special functions can be deposited on the navigation keys [▲] [▼], in particular this function is made for devices in housing size 48x24mm which do not have a 4th key ([O]-key). If the min/max/-memory is activated with <i>EHTR</i>, all measured min/max-values are safed during operation and can be recalled via the navigation keys. The values get lost by re-start of the device. If the threshold value correction <i>LI.12</i> or <i>LI.34</i> is choosen, the values of the threshold can be changed during operation without disturbing the operating procedure. With <i>TARAR</i> the device is tared to zero and safed permanently as Offset. The device confirms the correct taring by showing <i>00000</i> in the display. <i>SETTA</i> changes into the offset value and can be changed via the navigation keys [▲] [▼]. The configuration of <i>EHT.RE</i> deletes the min/max-memory.</p>

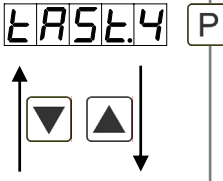
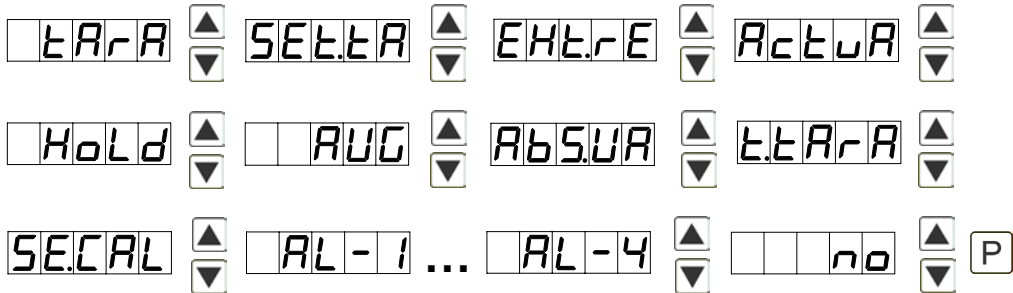
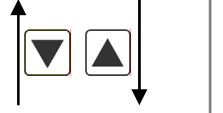
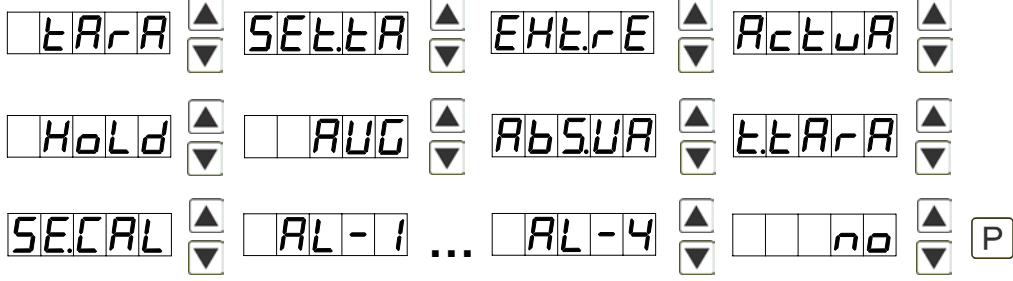
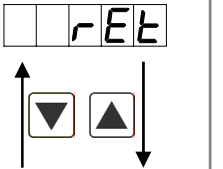
Menu level	Parameterisation level
	<p><b>Continuation of „Assignment (deposit) of key functions, TAST“</b></p> <p>Under <i>ACTUA</i> the measurand is shown, after this the display returns to the parametrised display value. If <i>ABS.UR</i> (absolute value) was selected, the display shows the value that has been measured since voltage connection, without consideration of a previous taring. The adjustment of the brightness of display is done via <i>LIGHT</i>; this adjustment is not saved and gets lost by restart of the device. If <i>NO</i> is selected, the navigation keys are without any function in the operation mode.</p>
	<p><b>Special function [O]-key, TAST.4:</b> Default: <i>NO</i></p>  <p>For the operation mode, special functions can be laid on the [O]-key. This function is triggered by pushing the key. With <i>TARA</i> the display is tared to zero and is saved permanently as Offset. The display confirms the correct taring by showing <i>00000</i> in the display. <i>SET.TA</i> switches into the offset value and can be changed via the direction keys [▲] [▼]. <i>EHT.RE</i> deletes the min/max-memory. <i>ACTUA</i> shows the measuring value. Then the display switches to the parametrised display value. The same goes for <i>AVG</i>, here the sliding average value is displayed. At selected <i>HOLD</i> the instant value is held by pushing the [O]-key and updated by releasing the key. Advice: <i>HOLD</i> can only be activated if <i>HOLD</i> was selected under parameter <i>DISPL</i>. If <i>ABS.UR</i> (absolute value) was selected, the display shows the values that have been measured since the voltage has been connected, without consideration of a previous taring. With <i>T.TARA</i> (temporarily Tara) the Offset is determined by rising shoulder of the digital input and kept only for the period of the signal. Via <i>SE.CAL</i> a sensor calibration is done by pushing the zero-key, the flow diagram is shown in <i>chapter 8</i>. At <i>AL-1...AL-8</i> an output can be set and therewith e.g. a switch of the metering point can be done. If <i>NO</i> is selected, the [O]-key has no function in the operation mode.</p>
	<p><b>Special function digital input, DIG.IN:</b> Default: <i>NO</i></p>  <p>For the operation mode, the above shown parameters can be laid on the optional digital input, too. Functions description see <i>TAST.4</i>.</p>
	<p><b>Back to menu group level, RET:</b></p> <p>With [P] the selection is confirmed and the device changes into menu group level „-FCT-“.</p>

### 5.4.3. Safety parameters

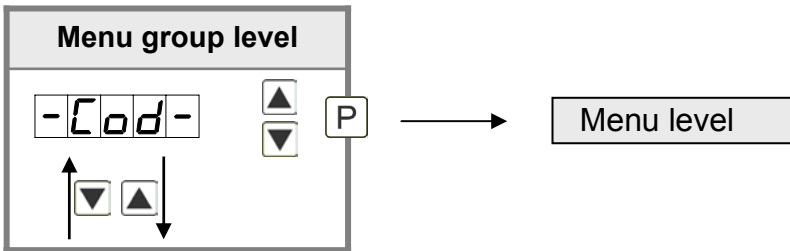



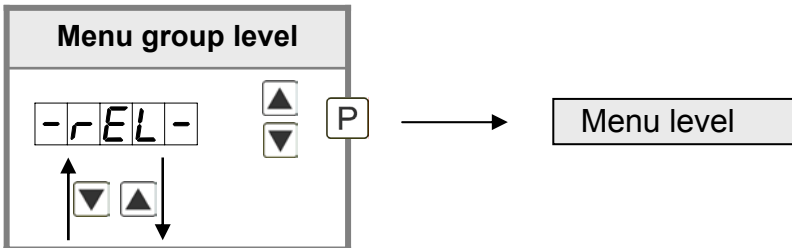

Menu level	Parameterisation level
	<p><b>Adjustment of user code, <i>U.CODE</i> :</b> Default: 0000</p> <p>Via this code reduced sets of parameters <i>OUT.LE</i> and <i>AL.LEV</i> can be unlocked during locked programming. Further parameters are not available via this code. The <i>U.CODE</i> can only be changed via the correct input of the <i>R.CODE</i> (Master code).</p>
	<p><b>Master code, <i>R.CODE</i>:</b> Default: 1234</p> <p>By entering <i>R.CODE</i> the device will be released and all parameters unlocked.</p>
	<p><b>Release/lock alarm parameters, <i>AL.LEU</i>:</b> Default: ALL</p> <p>This parameter describes the user release/user lock of the alarm.</p> <ul style="list-style-type: none"> <li>- <i>LIMIT</i>, here only the range of value of the threshold values 1-4 can be changed.</li> <li>- <i>ALRM.L</i>, here the range of value and the alarm trigger can be changed.</li> <li>- <i>ALL</i>, all alarm parameters are released.</li> <li>- <i>NO</i>, all alarm parameters are locked.</li> </ul>
	<p><b>Back to menu group level, <i>RET</i>:</b></p> <p>With [P] the selection is confirmed and the device changes into menu group level „-COD-“.</p>

5.4.4. Relay functions





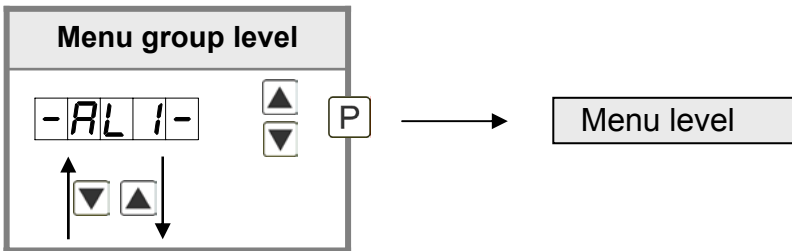

Menu level	Parameterisation level												
	<p><b>Alerting relay 1, REL-1:</b> Default: AL-1</p> <p>REL-1 P AL-1 ... AL-4 ▲▼ AL-n1 ... AL-n4 ▲▼</p> <p>LOGIC ▲▼ OFF ▲▼ On ▲▼ P</p> <p>Each setpoint (optional) can be linked up via 4 alarms (by default). This can either be inserted at activated alarms <i>AL1/4</i> or de-activated alarms <i>ALn1/4</i>. If <i>LOGIC</i> is selected, logical links are available in the menu level <i>LOG-1</i> and <i>COM-1</i>. One can only get to these two menu levels via <i>LOGIC</i>, at all other selected functions, these two parameters are overleaped. Via <i>ON/OFF</i> the setpoints can be activated/de-activated, in this case the output and the setpoint display are set/not set on the front of the device. With [P] the selection is confirmed and the device changes into menu level.</p>												
	<p><b>Logic relay 1, LOG-1</b> Default: OR</p> <p>LOG-1 P or ▲▼ nor ▲▼ And ▲▼ nAnd ▲▼ P</p> <p>Here, the switching behavior of the relay is defined via a logic link, the following schema describes these functions with inclusion of <i>AL-1</i> and <i>AL-2</i>. This parameter can only be selected if <i>LOGIC</i> was selected under <i>REL-1</i>.</p> <table border="1"> <tbody> <tr> <td>or</td> <td><math>A1 \vee A2</math></td> <td>As soon as a selected alarm is activated, the relay operates. Equates to operating current principle.</td> </tr> <tr> <td>nor</td> <td><math>\overline{A1 \vee A2} = \overline{A1} \wedge \overline{A2}</math></td> <td>The relay operates only, if no selected alarm is active. Equates to quiescent current principle.</td> </tr> <tr> <td>And</td> <td><math>A1 \wedge A2</math></td> <td>The relay operates only, if all selected alarms are active.</td> </tr> <tr> <td>nAnd</td> <td><math>\overline{A1 \wedge A2} = \overline{A1} \vee \overline{A2}</math></td> <td>As soon as a selected alarm is not activated, the relay operates.</td> </tr> </tbody> </table> <p>With [P] the selection is confirmed and the device changes into menu level.</p>	or	$A1 \vee A2$	As soon as a selected alarm is activated, the relay operates. Equates to operating current principle.	nor	$\overline{A1 \vee A2} = \overline{A1} \wedge \overline{A2}$	The relay operates only, if no selected alarm is active. Equates to quiescent current principle.	And	$A1 \wedge A2$	The relay operates only, if all selected alarms are active.	nAnd	$\overline{A1 \wedge A2} = \overline{A1} \vee \overline{A2}$	As soon as a selected alarm is not activated, the relay operates.
or	$A1 \vee A2$	As soon as a selected alarm is activated, the relay operates. Equates to operating current principle.											
nor	$\overline{A1 \vee A2} = \overline{A1} \wedge \overline{A2}$	The relay operates only, if no selected alarm is active. Equates to quiescent current principle.											
And	$A1 \wedge A2$	The relay operates only, if all selected alarms are active.											
nAnd	$\overline{A1 \wedge A2} = \overline{A1} \vee \overline{A2}$	As soon as a selected alarm is not activated, the relay operates.											
	<p><b>Alarms for relay 1, COM-1:</b> Default: A.1</p> <p>COM-1 P A.1 ▲▼ A.2 ▲▼ ... A.1234 ▲▼ P</p> <p>The allocation of the alarms to relay 1 happens via this parameter, one alarm or a group of alarms can be chosen. This parameter can only be selected if <i>LOGIC</i> was selected under <i>REL-1</i>. With [P] the selection is confirmed and the device changes into menu level.</p>												

Menu level	Parameterisation level												
<p><b>REL-2</b> P</p> 	<p><b>Alerting relay 2, REL-2:</b> Default: AL-2</p> <p>AL-1 .... AL-4 ▲▼ AL-n1 .... AL-n4 ▲▼</p> <p>LOGIC ▲▼ OFF ▲▼ On ▲▼ P</p> <p>Each setpoint (optional) can be linked up via 4 alarms (by default). This can either be inserted at activated alarms AL1/4 or de-activated alarms ALN/4. If LOGIC is selected, logical links are available in the menu level LOG-1 and COM-1. One can only get to these two menu levels via LOGIC, at all other selected functions, these two parameters are overleaped. Via ON/OFF the setpoints can be activated/de-activated, in this case the output and the setpoint display are set/not set on the front of the device. With [P] the selection is confirmed and the device changes into menu level.</p>												
<p><b>LOG-2</b> P</p> 	<p><b>Logic relay 2, LOG-2:</b> Default: OR</p> <p>or ▲▼ nor ▲▼ And ▲▼ nAnd ▲▼ P</p> <p>Here, the switching behavior of the relay is defined via a logic link, the following schema describes these functions with inclusion of AL-1 and AL-2. This parameter can only be selected if LOGIC was selected under REL-1.</p> <table border="1" data-bbox="336 1099 1497 1429"> <tbody> <tr> <td data-bbox="336 1099 523 1178">or</td> <td data-bbox="528 1099 826 1178"><math>A1 \vee A2</math></td> <td data-bbox="831 1099 1497 1178">As soon as a selected alarm is activated, the relay operates. Equates to operating current principle.</td> </tr> <tr> <td data-bbox="336 1184 523 1263">nor</td> <td data-bbox="528 1184 826 1263"><math>\overline{A1 \vee A2} = \overline{A1} \wedge \overline{A2}</math></td> <td data-bbox="831 1184 1497 1263">The relay operates only, if no selected alarm is active. Equates to quiescent current principle.</td> </tr> <tr> <td data-bbox="336 1270 523 1348">And</td> <td data-bbox="528 1270 826 1348"><math>A1 \wedge A2</math></td> <td data-bbox="831 1270 1497 1348">The relay operates only, if all selected alarms are active.</td> </tr> <tr> <td data-bbox="336 1355 523 1433">nAnd</td> <td data-bbox="528 1355 826 1433"><math>\overline{A1 \wedge A2} = \overline{A1} \vee \overline{A2}</math></td> <td data-bbox="831 1355 1497 1433">As soon as a selected alarm is not activated, the relay operates.</td> </tr> </tbody> </table> <p>With [P] the selection is confirmed and the device changes into menu level.</p>	or	$A1 \vee A2$	As soon as a selected alarm is activated, the relay operates. Equates to operating current principle.	nor	$\overline{A1 \vee A2} = \overline{A1} \wedge \overline{A2}$	The relay operates only, if no selected alarm is active. Equates to quiescent current principle.	And	$A1 \wedge A2$	The relay operates only, if all selected alarms are active.	nAnd	$\overline{A1 \wedge A2} = \overline{A1} \vee \overline{A2}$	As soon as a selected alarm is not activated, the relay operates.
or	$A1 \vee A2$	As soon as a selected alarm is activated, the relay operates. Equates to operating current principle.											
nor	$\overline{A1 \vee A2} = \overline{A1} \wedge \overline{A2}$	The relay operates only, if no selected alarm is active. Equates to quiescent current principle.											
And	$A1 \wedge A2$	The relay operates only, if all selected alarms are active.											
nAnd	$\overline{A1 \wedge A2} = \overline{A1} \vee \overline{A2}$	As soon as a selected alarm is not activated, the relay operates.											
<p><b>COM-2</b> P</p> 	<p><b>Alarms for relay 2, COM-2:</b> Default: A.2</p> <p>A.1 ▲▼ A.2 ▲▼ .... A.1234 ▲▼ P</p> <p>The allocation of the alarms to relay 1 happens via this parameter, one alarm or a group of alarms can be chosen. This parameter can only be selected if LOGIC was selected under REL-1. With [P] the selection is confirmed and the device changes into menu level.</p>												
<p><b>RET</b></p> 	<p><b>Back to menu group level, RET:</b></p> <p>With [P] the selection is confirmed and the device changes into menu group level „- REL -“.</p>												

5.4.5. Alarm parameters

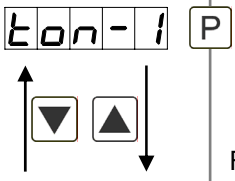

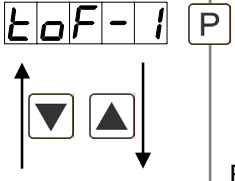
Menu level	Parameterisation level
<p data-bbox="124 748 293 792">AL1-1</p> <p data-bbox="316 757 347 792">P</p> <p data-bbox="134 815 277 927">↑ ↓</p>	<p data-bbox="352 651 708 680"><b>Dependency of alarm1, ALRM.1:</b></p> <p data-bbox="352 692 523 721">Default: <i>ACTUA</i></p> <p data-bbox="384 734 1331 904"> <span>ACTUA</span> <span>MINUA</span> <span>MAXUA</span> <span>HOLD</span>  <span>AUC</span> <span>ABSUA</span> <span>EHTER</span> </p> <p data-bbox="352 927 1485 1070">The dependency of alarm1 can be related to special functions, in detail these are the current measurand, the min-value, the max-value, the absolute value or the sliding average value. If <i>HOLD</i> is selected the alarm is hold and processed just after deactivation of <i>HOLD</i>. <i>EHTER</i> causes the dependency either by pressing the [O]-key on the front of the housing or by an external signal via the digital input. With [P] the selection is confirmed and the device changes into menu level.</p> <p data-bbox="352 1081 472 1111"><b>Example:</b></p> <p data-bbox="352 1122 1485 1205">By using the maximum value <i>ALARM.1 = MAXUA</i> in combination with a threshold monitoring <i>FU-1 = HIGH</i>, an alarm confirmation can be realised. Use the navigation keys or the fourth key for confirmation.</p>
<p data-bbox="124 1301 293 1346">LI-1</p> <p data-bbox="316 1310 347 1346">P</p> <p data-bbox="134 1368 277 1458">↑ ↓</p>	<p data-bbox="352 1223 719 1252"><b>Threshold values /Limits, LI-1:</b></p> <p data-bbox="352 1263 523 1292">Default: <i>2000</i></p> <p data-bbox="384 1305 1075 1375"> <span>0</span> <span>0</span> <span>0</span> <span>0</span> <span>0</span> <span>0</span> <span>0</span> </p> <p data-bbox="352 1424 1422 1453">This limit value defines the threshold, that leads to an activation / deactivation of the alarm.</p>
<p data-bbox="124 1547 293 1592">HY-1</p> <p data-bbox="316 1556 347 1592">P</p> <p data-bbox="134 1615 277 1704">↑ ↓</p>	<p data-bbox="352 1469 815 1498"><b>Hysteresis for threshold values, HY-1:</b></p> <p data-bbox="352 1509 528 1538">Default: <i>00000</i></p> <p data-bbox="384 1552 1075 1621"> <span>0</span> <span>0</span> <span>0</span> <span>0</span> <span>0</span> </p> <p data-bbox="352 1682 1485 1742">The difference to the threshold value that causes the delay of the actuation of the alarm, is defined by the hysteresis.</p>
<p data-bbox="124 1839 293 1883">FU-1</p> <p data-bbox="316 1848 347 1883">P</p> <p data-bbox="134 1906 277 1995">↑ ↓</p>	<p data-bbox="352 1760 1066 1789"><b>Function for threshold value exceedance/undercut, FU-1:</b></p> <p data-bbox="352 1800 507 1830">Default: <i>HIGH</i></p> <p data-bbox="384 1843 916 1912"> <span>HIGH</span> <span>LOW</span> </p> <p data-bbox="352 1928 1485 2069">The limit value undercut can be selected with <i>LOW</i> (LOW = lower limit value) and limit value exceedance can be selected with <i>HIGH</i> (HIGH = upper limit value). If e.g. limit value 1 is on a switching threshold of 100 and occupied with function <i>HIGH</i>, the alarm will be activated by reaching the threshold. If the limit value is allocated to <i>LOW</i>, an alarm will be activated by undercut of the threshold.</p>

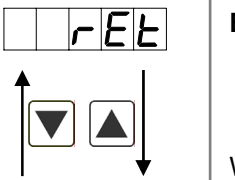
Menu level	Parameterisation level
	<p><b>Switching-on delay, <i>TON-1</i>:</b> Default: <i>000</i></p> <p>0 P 0 P 0 P   P</p> <p>For limit value 1 one can preset a delayed switching-on of 0-100 seconds.</p>
	<p><b>Switching-off delay, <i>TOF-1</i>:</b> Default: <i>000</i></p> <p>0 P 0 P 0 P   P</p> <p>For limit value 1 one can preset a delayed switching-off of 0-100 seconds.</p>
	<p><b>Back to menu group level, <i>RET</i>:</b></p> <p>With [P] the selection is confirmed and the device changes into menu group level „- AL1 -“.</p>

The same applies to *-AL2-* to *-AL4-*.

### Programming interlock:

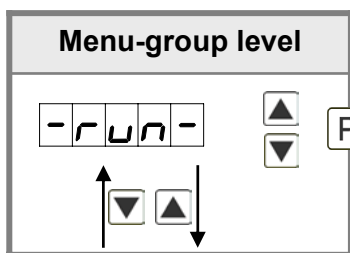

Description see page 11, menu-level *RUN*

## 6. Reset to factory settings

To return the unit to a **defined basic state**, a reset can be carried out to the default values.

The following procedure should be used:

- Switch off the power supply
- Press button [P]
- Switch on voltage supply and press [P]-button until „- - - -“ is shown in the display.

With reset, the default values of the program table are loaded and used for subsequent operation. This sets the unit back to the state in which it was supplied.

**Caution! All application-related data are lost.**



## 7. Alarms / Relays

This device has 4 virtual alarms that can monitor one limit value in regard of an undercut or exceedance. Each alarm can be allocated to an optional relay output S1-S2; furthermore alarms can be controlled by events like e.g. Hold or min-/max-value.

Function principle of alarms / relays	
Alarm / Relay x	Deactivated, instantaneous value, min-/max-value, Hold-value, sliding average value or an activation via the digital input or the [O]-key.
Switching threshold	Threshold / limit value of the change-over
Hysteresis	Broadness of the window between the switching thresholds
Working principle	Operating strom / Quiescent current

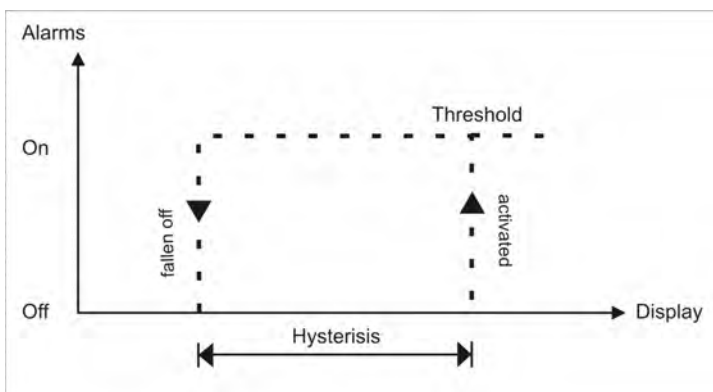

### Operating current

By operating current the alarm S1-S2 is off below the threshold and on on reaching the threshold.

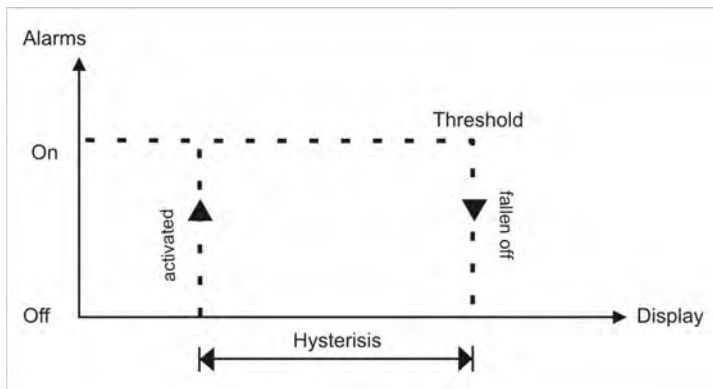

### Quiescent current

By quiescent current the alarm S1-S2 is on below the threshold and switched off on reaching the threshold.

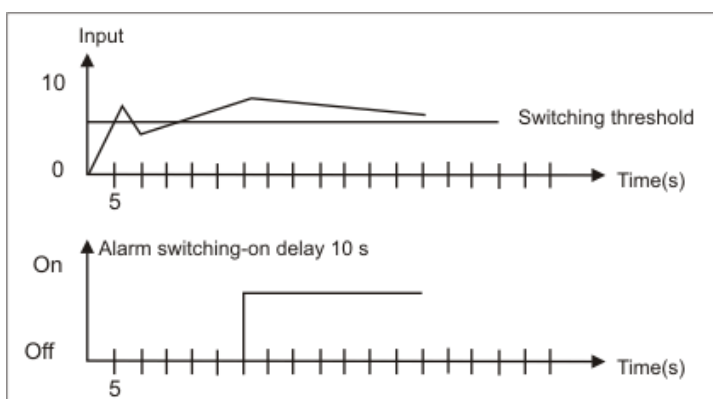

### Switching-on delay

The switching-on delay is activated via an alarm and e.g. switched 10 seconds after reaching the switching threshold, a short-term exceedance of the switching value does not cause an alarm, respectively does not cause a switching operation of the relay. The switching-off delay operates in the same way, keeps the alarm / the relay switched longer for the parameterised time.

## 8. Sensor calibration Offset/Final value

The device is equipped with a semi-automatic sensor calibration (*SENSF*). A switching output operates the trimming resistor, which exists in some sensors. An adjustment of offset and final value takes place, after which the sensor can be used directly. Depending on parameterisation, the calibration can be realized via the fourth key or via the digital input. It is possible to key during the calibration steps. So, reference signals can be connected manually. However the calibration will be interrupted after 30 seconds.

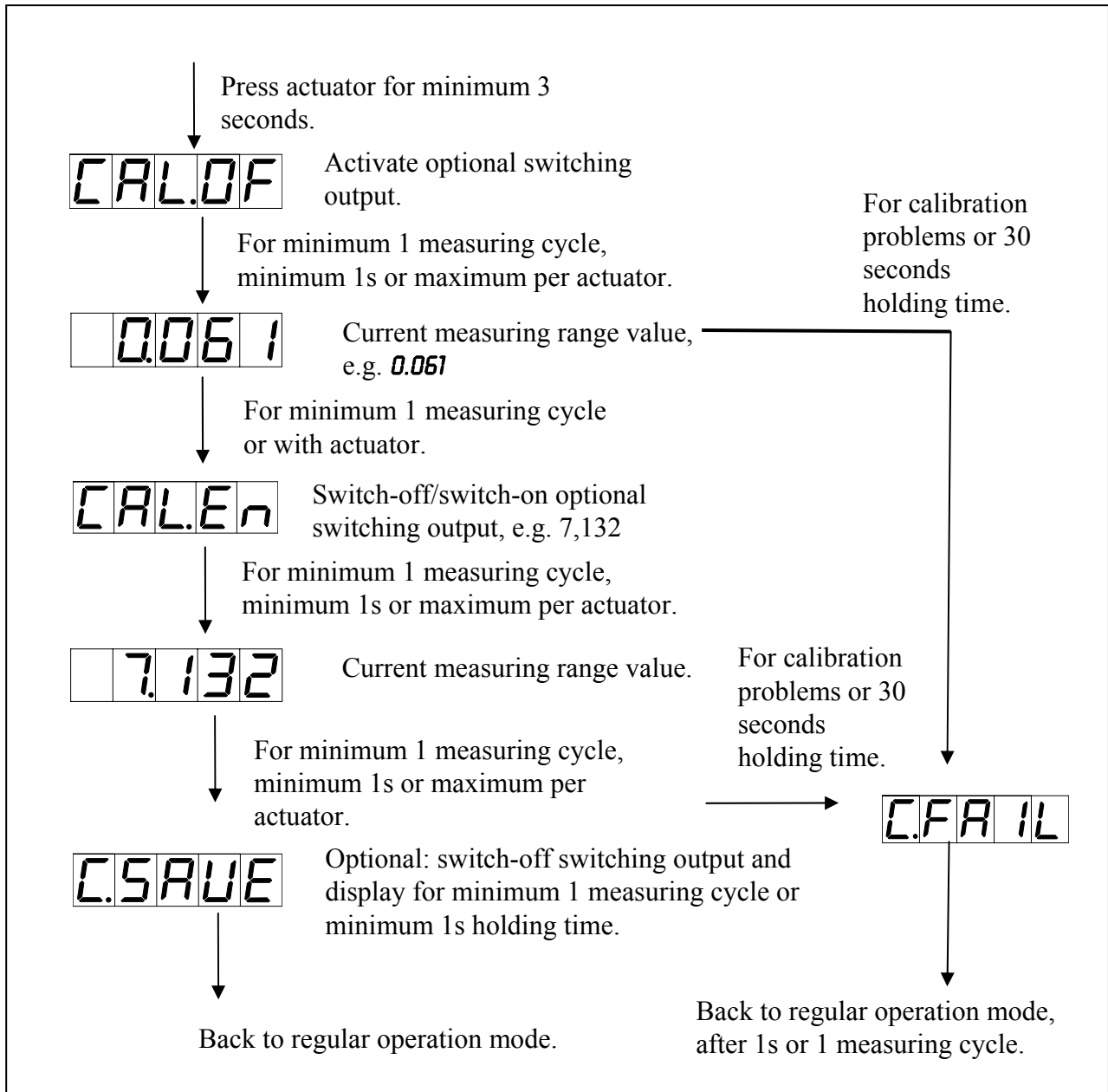

## 9. Technical data

<b>Housing</b>	
<b>Dimensions</b>	96x48x70 mm (BxHxD)
	96x48x89 mm (BxHxD) including plug-in terminal
Panel cut-out	92.0 <sup>+0.8</sup> x 45.0 <sup>+0.6</sup> mm
Wall thickness	up to 15 mm
Fixing	screw elements
Material	PC Polycarbonate, black, UL94V-0
Sealing material	EPDM, 65 Shore, black
Protection class	standard IP65 (front), IP00 (back side)
Weight	approx. 200 g
Connection	plug-in terminal; wire cross-section up to 2.5 mm <sup>2</sup>
<b>Display</b>	
Digit height	14 mm
Segment colour	red (optional green, orange or blue)
Display range	-19999 up to 99999
Setpoints	one LED per setpoint
Overflow	horizontal bars at the top
Underflow	horizontal bars at the top
Display time	0.1 to 10.0 seconds
<b>Input</b>	
Sensor sensitivity	1mV/V, 2mV/V, 3.3mV/V, free up to 4 mV/V
Measuring bridge	250 – 500 Ω / 20 – 40 mA
Measuring error	0,2% of measuring range in electromagnetic dominated environment, 1% of measuring range in industrial invironment with strong disturbing source
Digital input	< 2.4 V OFF, 10 V ON, max. 30 VDC R <sub>i</sub> ~ 5 kΩ
Sensor calibration	always required
<b>Accuracy</b>	
Temperature drift	100 ppm / K
Measuring time	0.1...10.0 seconds
Measuring principle	U/F-conversion
Resolution	approx. 18 Bit at 1s measuring time, 3.3 mV/V measuring range

<b>Output</b>	
Switching outputs	
Relay with change-over contacts Switching cycles	250 VAC / 5 AAC; 30 VDC / 5 ADC 30 x 10 <sup>3</sup> at 5 AAC, 5 ADC ohm resistive burden 10 x 10 <sup>6</sup> mechanically Diversification according to DIN EN50178 / Characteristics according to DIN EN60255
<b>Power supply</b>	230 VAC +/- 10 % max. 10 VA 10-30 VDC galv. insulated, max. 4 VA
<b>Memory</b>	
	EEPROM
Data life	≥ 100 years at 25°C
<b>Ambient conditions</b>	
Working temperature	0...50°C
Storing temperature	-20...80°C
Weathering resistance	relative humidity 0-80% on years average without dew
<b>EMV</b>	
	EN 61326
<b>CE-sign</b>	
	Conformity according to directive 2004/108/EG
<b>Safety standard</b>	
	According to low voltage directive 2006/95/EG EN 61010; EN 60664-1

## 10. Safety advices

Please read the following safety advice and the assembly *chapter 2* before installation and keep it for future reference.

### Proper use

The **M2-1W-device** is designed for the evaluation and display of sensor signals.



**Danger!** Careless use or improper operation can result in personal injury and/or damage to the equipment.

### Control of the device

The panel meters are checked before dispatch and sent out in perfect condition. Should there be any visible damage, we recommend close examination of the packaging. Please inform the supplier immediately of any damage.



### Installation

The **M2-1W-device** must be installed by a suitably **qualified specialist** (e.g. with a qualification in industrial electronics).

### Notes on installation

- There must be no magnetic or electric fields in the vicinity of the device, e.g. due to transformers, mobile phones or electrostatic discharge.
- The **fuse rating** of the supply voltage should not exceed a value of **6A N.B. fuse**.
- Do not install **inductive consumers** (relays, solenoid valves etc.) near the device and **suppress** any interference with the aid of RC spark extinguishing combinations or free-wheeling diodes.
- Keep input, output and supply lines separate from one another and do not lay them parallel with each other. Position “go” and “return lines” next to one another. Where possible use twisted pair. So, you receive best measuring results.
- Screen off and twist sensor lines. Do not lay current-carrying lines in the vicinity. Connect the **screening on one side** on a suitable potential equaliser (normally signal ground).
- The device is not suitable for installation in areas where there is a risk of explosion.
- Any electrical connection deviating from the connection diagram can endanger human life and/or can destroy the equipment.
- The terminal area of the devices is part of the service. Here electrostatic discharge needs to be avoided. Attention! High voltages can cause dangerous body currents.
- Galvanic insulated potentials within one complex need to be placed on an appropriate point (normally earth or machines ground). So, a lower disturbance sensibility against impacted energy can be reached and dangerous potentials, that can occur on long lines or due to faulty wiring, can be avoided.

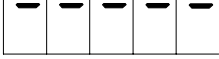
## 11. Error elimination

	Error description	Measures
1.	<p>The unit permanently indicates overflow.</p> 	<ul style="list-style-type: none"> <li>• The input has a very high measurement, check the measuring circuit.</li> <li>• With a selected input with a low voltage signal, it is only connected on one side or the input is open.</li> <li>• Not all of the activated switching points are parameterised. Check if the relevant parameters are adjusted correctly.</li> </ul>
2.	<p>The unit permanently shows underflow.</p> 	<ul style="list-style-type: none"> <li>• The input has a very low measurement, check the measuring circuit .</li> <li>• With a selected input with a low voltage signal, it is only connected on one side or the input is open.</li> <li>• Not all of the activated switching points are parameterised. Check if the relevant parameters are adjusted correctly.</li> </ul>
3.	<p>The word "<b>HELP</b>" lights up in the 7-segment display.</p>	<ul style="list-style-type: none"> <li>• The unit has found an error in the configuration memory. Perform a reset on the default values and re-configure the unit according to your application.</li> </ul>
4.	<p>Program numbers for parameterising of the input are not accessible.</p>	<ul style="list-style-type: none"> <li>• Programming lock is activated</li> <li>• Enter correct code</li> </ul>
5.	<p>"<b>ERR1</b>" lights up in the 7-segment display</p>	<ul style="list-style-type: none"> <li>• Please contact the manufacturer if errors of this kind occur.</li> </ul>
6.	<p>The device does not react as expected.</p>	<ul style="list-style-type: none"> <li>• If you are not sure that the device has been parameterised before, then follow the steps as written in <i>chapter 6</i>. and set it back to its delivery status.</li> </ul>

---

---

