User manual M3

Thermocouple type L, J, K, B, S, N, E, T, R



Technical features:

- red display from -19999...99999 digits (optional green, orange, blue or tricolour display)
- installation depth: 120 mm without plug-in screw terminal
- multi voltage power supply unit 100-240 VAC, alternatively 10-40 VDC galv. isolated
- adjustment via factory setting or directly on the sensor signal
- min-/max-memory with adjustable permanent display
- display flashing at threshold value exceedance / undercut
- flexible alarm system with adjustable delay times
- brightness control via parameter or front keys
- programming interlock via access code
- protection class IP65 at the front
- plug-in screw terminal
- optional: 1 or 2 relay outputs
- optional: 1 independently scalable analog output
- optional: interface RS232 or RS485
- accessories: pc-based configuration-kit PM-TOOL with CD & USB adapter
- on demand: devices for working temperatures of -25°C...60°C

Identification

STANDARD TYPES	ORDER NUMBER
Thermocouple Housing size: 96x24 mm	M3-3TR5B.040X.S70BD M3-3TR5B.040X.W70BD

Options – breakdown of order code:

	M	3	-	3	T	R	5	B.	0	4	0	X.	W	7	2	B	D		
Standard type M-line																			Dimension
Installation depth mm 144 mm (154 mm), incl. plug-in terminal																			<input type="checkbox"/> physical unit
Housing size B96xH24xD120 mm																			Version
Type of display Temperature																			<input type="checkbox"/> B
Display colours Blue Green Red Orange																			Switching points
Number of digits 5-digit																			<input type="checkbox"/> 0 without <input type="checkbox"/> 1 1 relay output <input type="checkbox"/> 2 2 relay outputs
Digit height 14 mm																			Protection class
Digital input without Interface RS232 Interface RS485																			<input type="checkbox"/> 1 without keypad, operation via programming plug on the back side <input type="checkbox"/> 7 IP65 / plug-in terminal
																			Voltage supply
																			<input type="checkbox"/> S 100-240 VAC <input type="checkbox"/> W 10-40 VDC galv. insulated
																			Measuring input
																			<input type="checkbox"/> X Type L, J, K, B, S, N, E, T, R
																			Analog output
																			<input type="checkbox"/> 0 without <input type="checkbox"/> X 0-10 VDC, 0/4-20 mA
																			Temperature devices
																			<input type="checkbox"/> 4 Thermocouple

Please state physical unit by order, e.g. °C

Contents

1.	Brief description	2
2.	Assembly	2
3.	Electrical connection	3
4.	Function description and operation	4
	4.1. Programming software PM-TOOL	5
5.	Setting up the device	6
	5.1. Switching on	6
	5.2. Standard parameterisation (flat operation level)	6
	Value assignment for the triggering of the signal input	
	5.3. Programming interlock „RUN“	8
	Activation/Deactivation of the programming interlock or change into professional or flat operation level	
	5.4. Extended parametersation (professional operation level)	9
	5.4.1. Signal input parameters „INP“	9
	Value assignment for the triggering of the signal input	
	5.4.2. General device parameters „FCT“	11
	Superior device functions like min/max permanent, brightness control, as well as the control of the keyboard layout	
	5.4.3. Safety parameters „COD“	13
	Assignment of user and master code to lock or to receive access to defined parameter such as analog output and alarms, etc.	
	5.4.4. Serial parameters „SER“	14
	Parameter for interface definition	
	5.4.5. Analog parameters „OUT“	15
	Analog output functions	
	5.4.6. Relay functions „REL“	17
	Parameter for setpoint definition	
	5.4.7. Alarm parameters „AL1...AL4“	18
	Actuator and dependencies of the alarms	
6.	Reset to factory settings	20
	Reset parameters onto the delivery state	
7.	Alarms / Relays	21
	Functional principle of the switching outputs	
8.	Interfaces	22
	Connection RS232 and RS485	
9.	Technical data	23
10.	Safety advices	25
11.	Error elimination	26

1. Brief description

The panel meter instrument **M3-3T** is a 5-digit device for Thermocouple and a visual threshold value monitoring via the display. The configuration happens via four keys at the front or by the optional PC software PM-TOOL. The integrated programming interlock prevents unrequested changes of parameters and can be unlocked again with an individual code. Optional available is one analog output for further evaluating in the unit.

With help of the two galvanic insulated setpoints (optional), free adjustable limit values can be controlled and reported to a superior master display.

The electrical connection is done via plug-in terminals on the back side.

Selectable functions like e.g. the recall of the min/max-value, a direct threshold value regulation during operation mode, complete the modern device concept.

2. Assembly

Please read the *Safety advice* on page 25 before installation and keep this user manual for future reference.

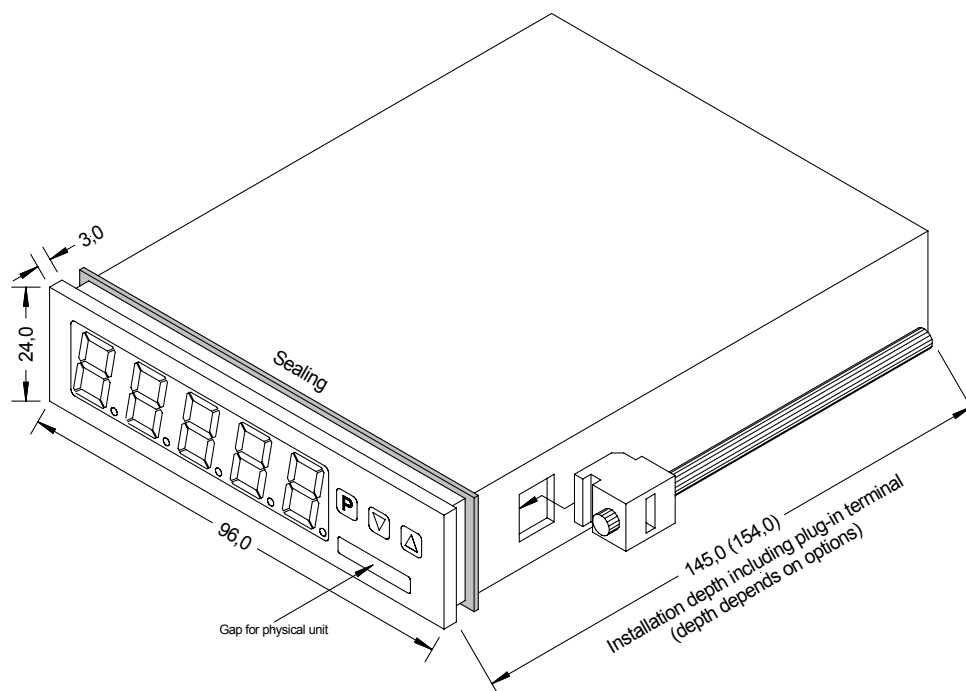

1. After removing the fixing elements, insert the device.
2. Check the seal to make sure it fits securely.
3. Click the fixing elements back into place and tighten the clamping screws by hand. Then use a screwdriver to tighten them another half a turn.

CAUTION! The torque should not exceed 0.1 Nm!

The dimension symbols can be exchanged before installation via a channel on the side!

3. Electrical connection

Type **M3-3VT5B.040X.S70BD** supply 100-240 VAC 50/60Hz, DC $\pm 10\%$
Type **M3-3VC5B.040X.W70BD** supply 10-40 VDC galv. isolated, 18-30 VAC 50/60Hz

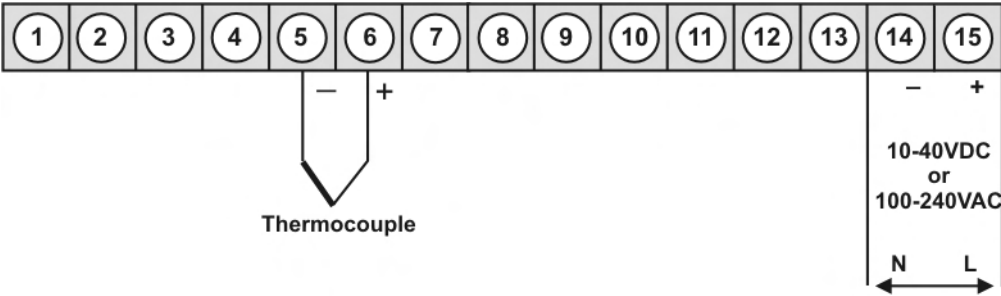

Options:

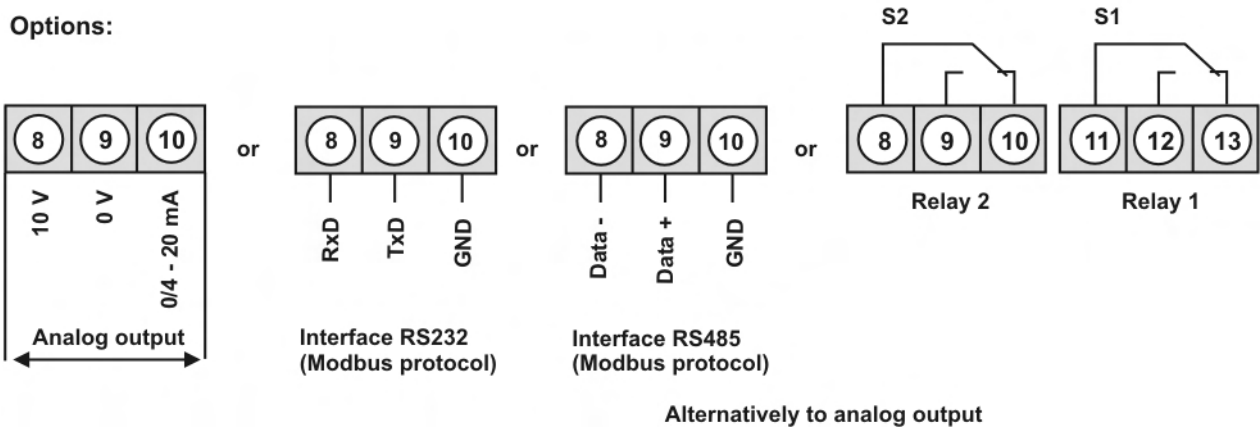

4. Function description and operation

Operation

The operation is divided into three different levels.

Menu level (delivery status)













This level is for the standard settings of the device. Only menu items which are sufficient to set the device into operation are displayed. To get into the professional level, run through the menu level and parameterise "**PROF**" under menu item **RUN**.

Menu group level (complete function volume)

Suited for complex applications as e.g. linkage of alarms, setpoint treatment, totaliser function etc. In this level function groups which allow an extended parameterisation of the standard settings are available. To leave the menu group level, run through this level and parameterise „**ULOC**„ under menu item **RUN**.

Parameterisation level:

Parameter deposited in the menu item can here be parameterised. Functions, that can be changed or adjusted, are always signalled by a flashing of the display. Settings that are made in the parameterisation level are confirmed with **[P]** and thus safed. By pressing the „**[O]-key**“ it leads to a break-off of the value input and to a change into the menu level. All adjustments are safed automatically by the device and changes into operating mode, if no further key operation is done within the next 10 seconds.

Level	Key	Description
Menu-level		Change to parameterisation level and deposited values.
	 	Keys for up and down navigation in the menu level.
		Change into operation mode.
Parameterisation-level		To confirm the changes made at the parameterization level.
	 	Adjustment of the value / the setting.
		Change into menu level or break-off in value input.
Menu-group-level		Change to menu level.
	 	Keys for up and down navigation in the menu group level.
		Change into operation mode or back into menu level.

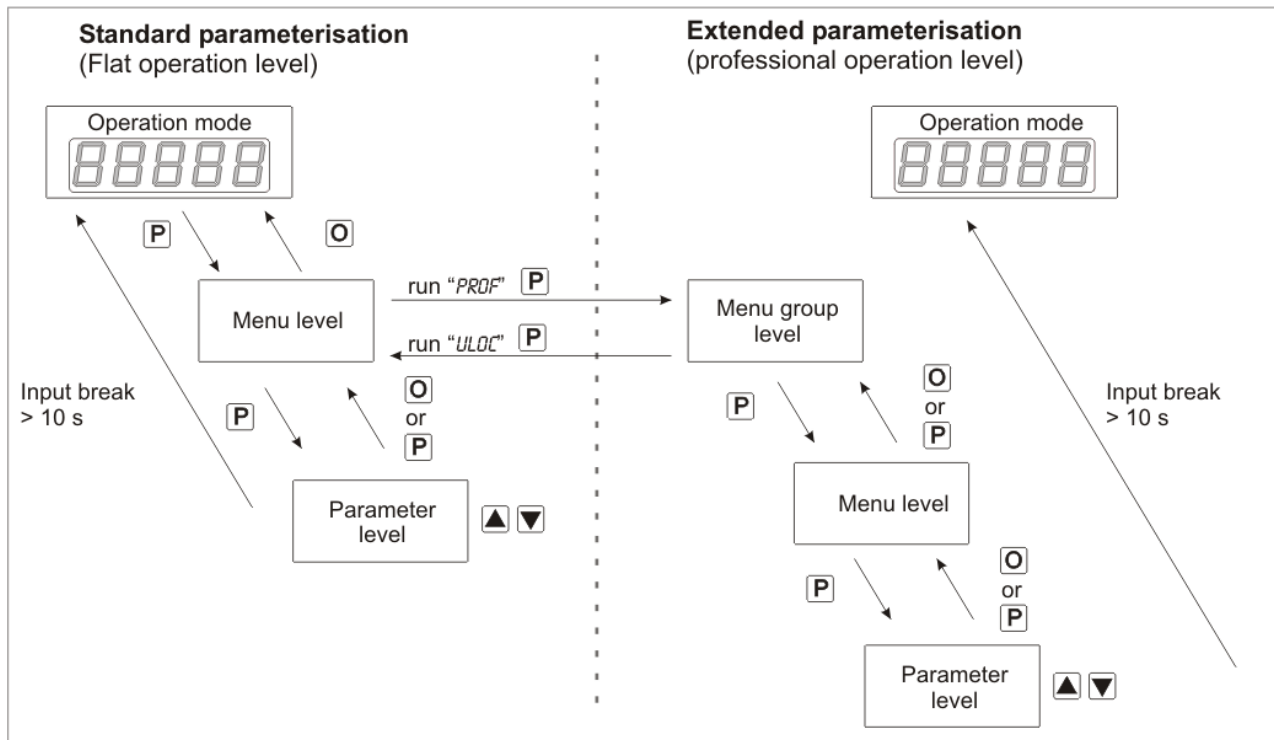
Function chart:**Underline:**

- P** Takeover
- O** Stop
- ▲** Value selection (+)
- ▼** Value selection (-)

4.1 Parameterisation software PM-TOOL:

Part of the PM-TOOL are the software on CD and an USB-cable with device adapter. The connection is done via a 4-pole micromatch-plug on the back side of the device, to the PC-side the connection ist done via an USB plug.

System requirements: PC incl. USB interface
Software: Windows XP, Windows VISTA

With this tool the device configuration can be generated, omitted and safed on the PC. The parameters can be changed via the easy to handle program surface, whereat the operating mode and the possible selection options can be preset by the program.

5. Setting up the device

5.1. Switching on

Once the installation is complete, you can start the device by applying the voltage supply. Before, check once again that all electrical connections are correct.









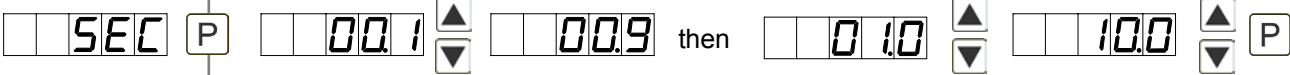
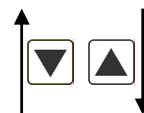

Starting sequence

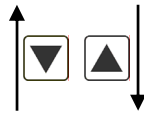

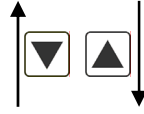

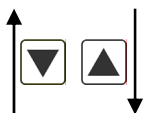

For 1 second during the switching-on process, the segment test (**8 8 8 8 8**) is displayed followed by an indication of the software type and, after that, also for 1 second the software version. After the starting sequence, the device switches to operation/display mode.

5.2. Standard parameterisation: (Flat operation level)

To parameterise the display, press the **[P]** key in operating mode for 1 second. The display then changes to the menu level with the first menu item **TYPE**.

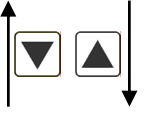
Menu level	Parameterisation level
	<p>Selection of the input signal, <i>TYPE</i>: Default: <i>TYPE.L</i></p> <p>Available are 9 types of thermocouple as input options (L, J, K, B, S, N, E, T, R). Confirm the selection with [P] and the display switches back to menu level.</p>
	<p>Type of temperature metering <i>UNIT</i>: Default: °C</p> <p>The temperature can be displayed in °C or in °F. Confirm the selection with [P] and the display switches back to menu level.</p>
	<p>Setting the decimal point, <i>DOT</i>: Default: <i>0.0</i></p> <p>The decimal point on the display and the physical unit can be changed with [▲] [▼]. If e.g. temperature measurement in °C is selected, then you can choose between 0°C and 0.0°C in the parameterisation level. Confirm with [P], the display then switches back to the menu level again.</p>
	<p>Impedance matching, <i>DOT</i>: Default: <i>0.0</i></p> <p>The value for the sensor calibration is selectable from the smallest to the highest digit with [▲] [▼] and confirmed with [P]. After the last digit the display switches back to the menu level again. The value calibration for a temperature measurement in °C can be adjusted between -20.0 and +20.0 and in °F between -36.0 and +36.0. If the type of the measurement is changed later, then the value is rounded.</p>

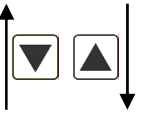
Menu level	Parameterisation level
	<p>Setting up the display time, SEC: Default: 1.0</p> <p>  </p> <p>The display time is set with [▲] [▼]. The display moves up in increments of 0.1 sec up to 1 sec and in increments of 1.0 sec up to 10.0 sec. Confirm the selection by pressing the [P] button. The display then switches back to the menu level again.</p>
	<p>Selection of analog output, OUT.RA: Default: 4-20</p> <p>  </p> <p>Three output signals are available: 0-10 VDC, 0-20 mA and 4-20 mA, with this function, the demanded signal is selected.</p>
	<p>Setting up the final value of the analog output, OUT.EN: Default: 900.0</p> <p>  </p> <p>The final value is adjusted from the smallest digit to the highest digit with [▲] [▼] and digit by digit confirmed with [P]. A minus sign can only be parameterised on the highest digit. After the last digit, the device changes back into menu level.</p>
	<p>Setting up the initial value of the analog output, OUT.OF: Default: -200.0</p> <p>  </p> <p>The final value is adjusted from the smallest digit to the highest digit with [▲] [▼] and digit by digit confirmed with [P]. A minus sign can only be parameterised on the highest digit. After the last digit, the device changes back into menu level.</p>
	<p>Threshold values / Limits, LI-1: Default: 200.0</p> <p>  </p> <p>This value defines the threshold, that activates/deactivates an alarm.</p>
	<p>Hysteresis for limit values, HY-1: Default: 0.0</p> <p>  </p> <p>The delayed reaction of the alarm is the difference to the threshold value, which is defined by the hysteresis.</p>

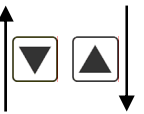
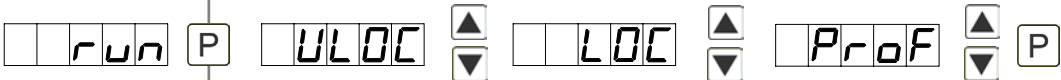

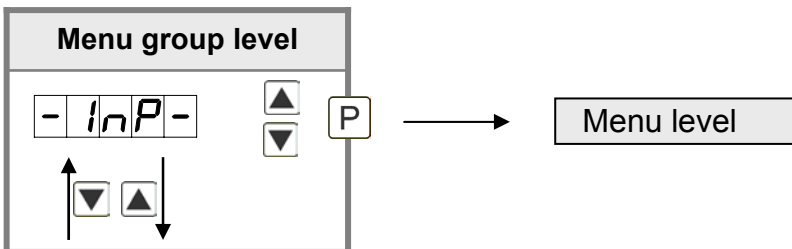

Menu level	Parameterisation level
	<p>Function for threshold value undercut /exceedance, FU-1: Default: <i>HIGH</i></p> <p></p> <p>A limit value undercut is selected with <i>LOW</i> (for LOW = lower limit value), a limit value exceedance with <i>HIGH</i> (for HIGH = higher limit value). If e.g. limit value 1 is on a threshold level of 100 and allocated with function <i>HIGH</i>, an alarm is activated by reaching of the threshold level. If the threshold value was allocated to <i>LOW</i>, an alarm will be activated by undercutting the threshold value, as long as the hysteresis is zero.</p>
<p>The same applies to LI-2 !</p>	
	<p>User code (4-digit number-combination, free available), U.CODE: Default: <i>0000</i></p> <p></p> <p>If this code was set (>0000), all parameters are locked for the user, if <i>LOC</i> has been selected before under menu item <i>RUN</i>. By pressing [P] for 3 seconds in operation mode, the display shows <i>CODE</i>. The <i>U.CODE</i> needs to be entered to get to the reduced number of parameter sets. The code has to be entered before each parameterisation, until the <i>A.CODE</i> (Master code) unlocks all parameters again.</p>
	<p>Master code (4-digit number-combination, free available), A.CODE: Default: <i>1234</i></p> <p></p> <p>All parameters can be unlocked with this code, after <i>LOC</i> has been activated under menu item <i>RUN</i>. By pressing [P] for 3 seconds in operation mode, the display shows <i>CODE</i> and enables the user to reach all parameters by entering the <i>A.CODE</i>. Under <i>RUN</i> the parameterisation can be activated permanently by selecting <i>ULOC</i> or <i>PROF</i>, thus at an anew pushing of [P] in operation mode, the code needs not to be entered again.</p>
<p>5.3. Programming interlock „RUN“</p>	
	<p>Activation / deactivation of the programming lock or completion of the standard parameterisation with change into menu group level (complete function range), RUN: Default: <i>ULOC</i></p> <p></p> <p>With the navigation keys [▲] [▼], you can choose between the deactivated key lock <i>ULOC</i> (works setting) and the activated key lock <i>LOC</i>, or the change into the menu group level <i>PROF</i>. Confirm the selection with [P]. After this, the display confirms the settings with "- - - -", and automatically switches to operating mode. If <i>LOC</i> was selected, the keyboard is locked. To get back into the menu level, press [P] for 3 seconds in operating mode. Now enter the <i>CODE</i> (works setting <i>1 2 3 4</i>) that appears using [▲] [▼] plus [P] to unlock the keyboard. <i>FAIL</i> appears if the input is wrong. To parameterise further functions <i>PROF</i> needs to be set. The device confirms this setting with „- - - -“, and changes automatically in operation mode. By pressing [P] for approx. 3 seconds in operation mode, the first menu group <i>IMP</i> is shown in the display and thus confirms the change into the extended parameterisation. It stays activated as long as <i>ULOC</i> or <i>LOC</i> is entered in menu group <i>RUN</i>.</p>

5.4. Extended parameterisation (Professional operation level)

5.4.1. Signal input parameters

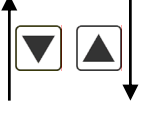
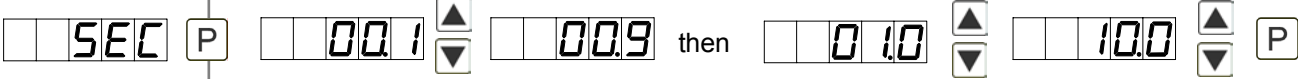

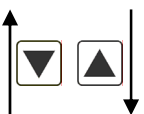

Menu level	Parameterisation level
	<p>Selection of the input signal, <i>TYPE</i>: Default: <i>TYPE.L</i></p> <p>Available are 9 types of thermocouple as input options (L, J, K, B, S, N, E, T, R). Confirm the selection with [P] and the display switches back to menu level.</p>
	<p>Type of temperature metering <i>UNIT</i>: Default: °C</p> <p>The temperature can be displayed in °C or in °F. Confirm the selection with [P] and the display switches back to menu level.</p>
	<p>Setting the decimal point, <i>DOT</i>: Default: 0.0</p> <p>The decimal point on the display and the physical unit can be changed with [▲] [▼]. If e.g. temperature measurement in °C is selected, then you can choose between 0°C and 0.0°C in the parameterisation level. Confirm with [P], the display then switches back to the menu level again.</p>
	<p>Impedance matching, <i>DOT</i>: Default: 0.0</p> <p>The value for the sensor calibration is selectable from the smallest to the highest digit with [▲] [▼] and confirmed with [P]. After the last digit the display switches back to the menu level again. The value calibration for a temperature measurement in °C can be adjusted between -20.0 and +20.0 and in °F between -36.0 and +36.0. If the type of the measurement is changed later, then the value is rounded.</p>

Menu level	Parameterisation level
	<p>Setting up the display time, SEC: Default: 1.0</p> <p>  </p> <p>The display time is set with [▲] [▼]. The display moves up in increments of 0.1 sec up to 1 sec and in increments of 1.0 sec up to 10.0 sec. Confirm the selection by pressing the [P] button. The display then switches back to the menu level again.</p>
	<p>Device undercut, DI.UND: Default: -19999</p> <p>  </p> <p>With this function the device undercut (_____) can be defined on a definite value. Exception is input type 4-20 mA, it already shows undercut at a signal <1 mA, so a sensor failure is marked.</p>
	<p>Display overflow, DI.OUE: Default: 99999</p> <p>  </p> <p>With this function the display overflow (-----) can be defined on a definite value.</p>
	<p>Back to menu group level, RET:</p> <p>With [P] the selection is confirmed and the device changes into menu group level „-IMP-“.</p>

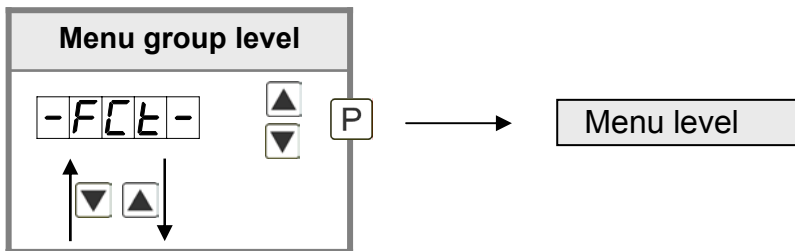
5.4.2. General device parameters

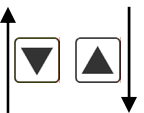

Menu level	Parameterisation level
<p>di.SEC P</p> <p>▲ ▼</p> <p>00.1 ▲ ▼ 00.9 then 0.10 ▲ ▼ 10.0 P</p>	<p>Display time, DISEC: Default: 01.0</p> <p>The display is set up with [▲] [▼]. Thereby it switches up to 1 second in increments of 0.1 seconds and up to 10.0 seconds in increments of 1.0. With [P] the selection is confirmed and the device changes into menu level.</p>
<p>round P</p> <p>▲ ▼</p> <p>00001 ▲ ▼ 00005 ▲ ▼ 00010 ▲ ▼ 00050 P</p>	<p>Rounding of display values, ROUND: Default: 00001</p> <p>This function is for instable display values, where the display value is changed in increments of 1, 5, 10 or 50. This does not affect the resolution of the optional outputs. With [P] the selection is confirmed and the device changes into menu level.</p>
<p>di SPL P</p> <p>▲ ▼</p> <p>ActuR ▲ ▼ MinUR ▲ ▼ MaxUR ▲ ▼ P</p>	<p>Display, DISPL: Default: ACTUA</p> <p>With this function the current measuring value or the min-/max value can be allocated to the display. With [P] the selection is confirmed and the device changes into menu level.</p>
<p>LIGHE P</p> <p>▲ ▼</p> <p>00 ▲ ▼ 15 ▲ ▼ P</p>	<p>Brightness control, LIGHT: Default: 15</p> <p>The brightness of the display can be adjusted in 16 levels from 00 = very dark to 15 = very bright via this parameter or alternatively via the navigation keys from the outside. During the start of the device the level that is deposited under this parameter will always be used, even though the brightness has been changed via the navigation keys in the meantime.</p>

Menu level	Parameterisation level
<p>FLASH P</p> 	<p>Display flashing, FLASH: Default: <i>NO</i></p> <p>no ▲ AL-1 ▲ AL-2 ▲ AL.12 ▲ ▼ ▼ ▼ ▼ ▼</p> <p>AL-3 ▲ AL-4 ▲ AL.34 ▲ ALAL ▲ P ▼ ▼ ▼ ▼ ▼</p> <p>A display flashing can be added as additional alarm function either to single or to a combination of off-limit condition. With <i>NO</i>, no flashing is allocated.</p>
<p>TRST P</p> 	<p>Assignment (deposit) of key functions, TRST: Default: <i>NO</i></p> <p>EHTR ▲ LI.12 ▲ LI.34 ▲ LIGHT ▲ ▼ ▼ ▼ ▼ ▼</p> <p>no ▲ P ▼ ▼</p> <p>For the operation mode, special functions can be deposited on the navigation keys [▲] [▼], in particular this function is made for devices in housing size 48x24 which do not have a 4th key ([O] key). If the min-/max-memory is activated with <i>EHTR</i>, all measured min/max-values are safed during operation and can be recalled via the navigation keys. The values get lost by re-start of the device. If the threshold value correction <i>LI.12</i> or <i>LI.34</i> is choosen, the values of the threshold can be changed during operation without disturbing the operating procedure. Under <i>LIGHT</i> the brightness can be changed during operation. If <i>NO</i> is selected, the navigation keys are without any function in the operation mode.</p>
<p>RET</p> 	<p>Back to menu group level, RET:</p> <p>With [P] the selection is confirmed and the device changes into menu group level „- FCT -“.</p>

5.4.3. Safety parameters

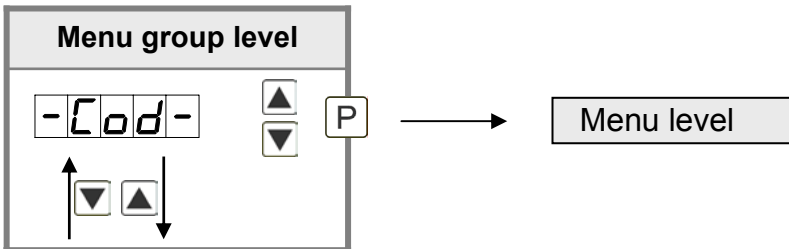

Menu level	Parameterisation level
	<p>User code <i>U.CODE</i>: Default: <i>0000</i></p> <p><i>U.CodE</i> P 0 P 0 P 0 P 0 P</p> <p>Via this code reduced sets of parameters can be set free. A change of the <i>U.CODE</i> can be done via the correct input of the <i>R.CODE</i> (master code).</p>
	<p>Master code, <i>R.CODE</i>: Default: <i>1234</i></p> <p><i>R.CodE</i> P 1 P 2 P 3 P 4 P</p> <p>By entering <i>R.CODE</i> the device will be unlocked and all parameters are released.</p>
	<p>Release/lock analog output parameter, <i>OUT.LE</i>: Default: <i>ALL</i></p> <p><i>Out.LE</i> P <input type="checkbox"/> <i>no</i> <i>En-Of</i> <i>Out.EO</i> <input type="checkbox"/> <i>ALL</i> P</p> <p>Analog output parameter can be locked or released for the user:</p> <ul style="list-style-type: none"> - At <i>EN-OF</i> the initial or final value can be changed in operation mode. - At <i>OUT.EO</i> the output signal can be changed from e.g. 0-20 mA to 4-20 mA or 0-10 VDC. - At <i>ALL</i> analog output parameters are released. - At <i>NO</i> all analog output parameters are locked.
	<p>Release/lock alarm parameters, <i>AL.LEU</i>: Default: <i>ALL</i></p> <p><i>AL.LEU</i> P <input type="checkbox"/> <i>no</i> <i>LIMIT</i> <i>ALrNL</i> <input type="checkbox"/> <i>ALL</i> P</p> <p>This parameter describes the user release/user lock of the alarm.</p> <ul style="list-style-type: none"> - <i>LIMIT</i>, here only the range of value of the threshold values 1-4 can be changed. - <i>ALrNL</i>, here the range of value and the alarm trigger can be changed. - <i>ALL</i>, all alarm parameters are released. - <i>NO</i>, all alarm parameters are locked.

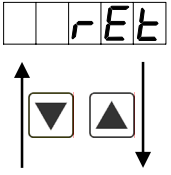
Menu level	Parameterisation level
	<p>Back to menu group level, <i>RET</i>:</p> <p>With [P] the selection is confirmed and the device changes into menu group level „- <i>COD</i> -“.</p>

5.4.4. Serial parameters

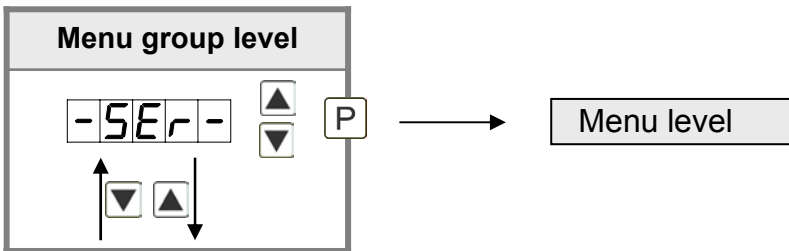

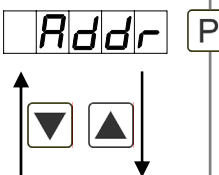
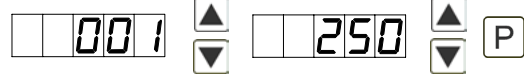
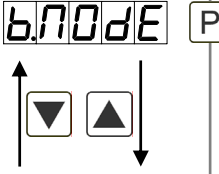
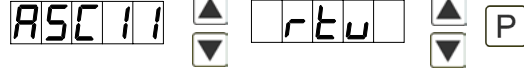
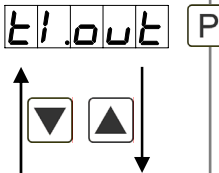
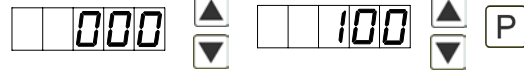
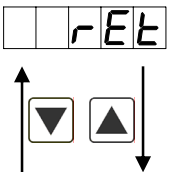

Menu level	Parameterisation level
	<p>Device address, <i>ADDR</i>: Default: <i>001</i></p>  <p>The device address is adjusted from the smallest to the largest digit with the navigation keys [▲] [▼] and confirmed digit per digit with [P]. A device address up to max. 250 is available. Interface data: Baudrate 9600 bit/s, 8 databyte, 1 stopbit, no parity (8n1).</p>
	<p>ModBus operating modes, <i>B.MODE</i>: Default: <i>ASCII</i></p>  <p>There are two different types of operating modes: <i>ASCII</i> and <i>RTU</i>. Modbus transfers no binary cycle, but the ASCII-Code. Thus it is directly readable, however the data throughput is smaller in comparison to the RTU. Modbus RTU (RTU = Remote Terminal Unit) transfers the data in binary-coded. This leads to a good data throughput, even though the data cannot be evaluated directly, as they first need to be transferred into a readable format.</p>
	<p>Timeout, <i>TIOU</i>: Default: <i>000</i></p>  <p>The monitoring of the data transfer is parameterised in seconds up to max. 100 seconds; there is no monitoring with an input of <i>000</i>. The timeout is adjusted from the smallest to the largest digit with the navigation keys [▲] [▼] and confirmed digit per digit with [P]. After the last digit the device changes back into menu level.</p>
	<p>Back to menu group level, <i>RET</i>:</p> <p>With [P] the selection is confirmed and the device changes into menu group level „- <i>SER</i> -“.</p>

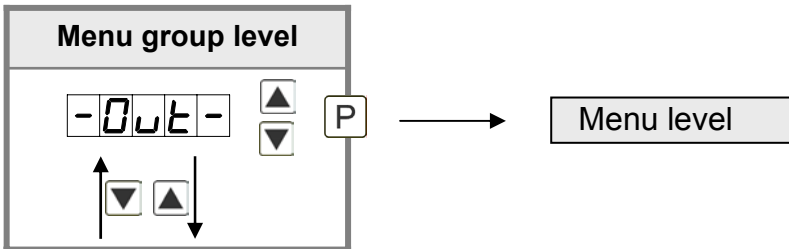
5.4.5. Analog output parameters



Menu level	Parameterisation level
	<p>Selection reference of analog output, <i>OUTPT</i>: Default: <i>ACTUA</i></p> <p><i>OUTPT</i> P <i>ACTUA</i> ▲▼ <i>MINUA</i> ▲▼ <i>MAXUA</i> ▲▼ P</p> <p>The analog output signal can refer to different functions, in detail these are the current measurand, the min-value or the max-value. With [P] the selection is confirmed and the device changes into menu level.</p>
	<p>Selection analog output, <i>OUT.RA</i>: Default: <i>4-20</i></p> <p><i>OUT.RA</i> P <i>0-10</i> ▲▼ <i>0-20</i> ▲▼ <i>4-20</i> ▲▼ P</p> <p>Three output signals are available 0-10 VDC, 0-20 mA and 4-20 mA. Select the desired signal with this function.</p>
	<p>Setting the final value of the analog output, <i>OUT.EN</i>: Default: <i>900.0</i></p> <p><i>OUT.EN</i> P <i>8</i> P <i>8</i> P <i>8</i> P <i>8</i> P <i>8</i> ▲▼ P</p> <p>The final value is adjusted from the smallest to the highest digit with [▲] [▼] and confirmed digit per digit with [P]. A minus sign can only be parameterised on the highest digit. After the last digit the device changes back into menu level.</p>
	<p>Setting the initial value of the analog output, <i>OUT.OF</i>: Default: <i>-200.0</i></p> <p><i>OUT.OF</i> P <i>8</i> P <i>8</i> P <i>8</i> P <i>8</i> P <i>8</i> ▲▼ P</p> <p>The initial value is adjusted from the smallest to the highest digit with [▲] [▼] and confirmed digit per digit with [P]. A minus sign can only be parameterised on the highest digit. After the last digit the device changes back into menu level.</p>

Menu level	Parameterisation level
	<p>Overflow behaviour, <i>O.FLOU</i>: Default: <i>EDGE</i></p> <p><i>O.FLOU</i> [P] <i>EDGE</i> ▲▼ <i>tO.END</i> ▲▼ <i>tO.OFF</i> ▲▼ <i>tO.MIN</i> ▲▼</p> <p><i>tO.MAX</i> ▲▼ [P]</p> <p>To recognise and evaluate faulty signals, e.g. by a controller, the overflow behaviour of the analog output can be defined. As overflow can be seen either <i>EDGE</i>, that means the analog output runs on the set limits e.g. 4 and 20 mA, or <i>TO.OFF</i> (input value smaller than initial value, analog output switches on e.g. 4 mA), <i>TO.END</i> (higher than final value, analog output switches on e.g. 20 mA). If <i>TO.MIN</i> or <i>TO.MAX</i> is set, the analog output switches on the smallest or highest possible binary value. This means that values of e.g. 0 mA, 0 VDC or values higher than 20 mA or 10 VDC can be reached. With [P] the selection is confirmed and the device changes into menu level.</p>
	<p>Back to menu group level, <i>RET</i>:</p> <p>With [P] the selection is confirmed and the device changes into menu group level „- OUT -“.</p>

5.4.6. Relay functions

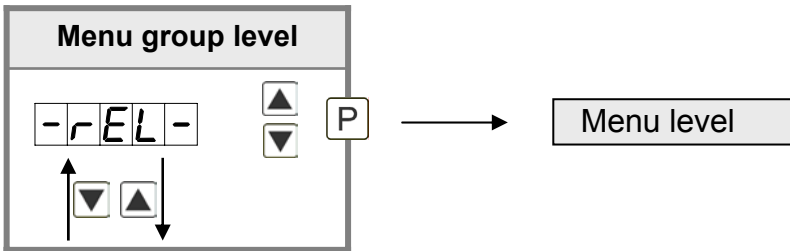



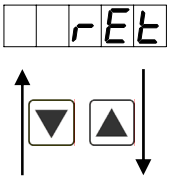



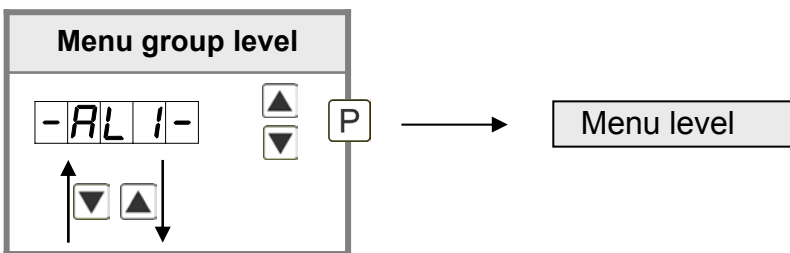

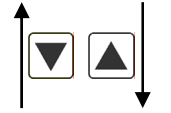

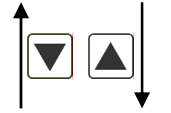

Menu level	Parameterisation level												
	<p>Alarm relay 1, REL-1: The same applies for relays 2 Default: <i>AL-1</i></p> <p>REL-1 P AL-1 AL-4 ▲▼ AL-n1 AL-n4 ▲▼</p> <p>LOGIC ▲▼ OFF ▲▼ On ▲▼ P</p> <p>Each setpoint (optional) can be linked up via 4 alarms (by default). This can either be inserted at activated alarms <i>AL-1/4</i> or de-activated alarms <i>ALN1/4</i>. If <i>LOGIC</i> is selected, logical links are available in the menu level <i>LOG-1</i> and <i>COM-1</i>. One can only get to these two menu levels via <i>LOGIC</i>, at all other selected functions, these two parameters are overleaped. Via <i>ON/OFF</i> the setpoints can be activated/de-activated, in this case the output and the setpoint display are set/not set on the front of the device. With [P] the selection is confirmed and the device changes into menu level.</p>												
	<p>Logic relay 1, LOG-1 Default: <i>OR</i></p> <p>LOG-1 P or ▲▼ nor ▲▼ And ▲▼ nAnd P</p> <p>Here, the switching behaviour of the relay is defined via a logic link, the following schema describes these functions with inclusion of <i>AL-1</i> and <i>AL-2</i>. This parameter is only possible if <i>LOGIC</i> was selected under <i>REL-1</i>.</p> <table border="1" data-bbox="347 1464 1487 1765"> <tbody> <tr> <td data-bbox="347 1464 523 1541">or</td> <td data-bbox="523 1464 826 1541">$A1 \vee A2$</td> <td data-bbox="826 1464 1487 1541">As soon as a selected alarm is activated, the relay operates. Equates to operating current principle.</td> </tr> <tr> <td data-bbox="347 1541 523 1617">nor</td> <td data-bbox="523 1541 826 1617">$\overline{A1 \vee A2} = \overline{A1} \wedge \overline{A2}$</td> <td data-bbox="826 1541 1487 1617">The relay operates only, if no selected alarm is active. Equates to quiescent current principle.</td> </tr> <tr> <td data-bbox="347 1617 523 1693">And</td> <td data-bbox="523 1617 826 1693">$A1 \wedge A2$</td> <td data-bbox="826 1617 1487 1693">The relay operates only, if all selected alarms are active.</td> </tr> <tr> <td data-bbox="347 1693 523 1765">nAnd</td> <td data-bbox="523 1693 826 1765">$\overline{A1 \wedge A2} = \overline{A1} \vee \overline{A2}$</td> <td data-bbox="826 1693 1487 1765">As soon as a selected alarm is not activated, the relay operates.</td> </tr> </tbody> </table> <p>With [P] the selection is confirmed and the device changes into menu level.</p>	or	$A1 \vee A2$	As soon as a selected alarm is activated, the relay operates. Equates to operating current principle.	nor	$\overline{A1 \vee A2} = \overline{A1} \wedge \overline{A2}$	The relay operates only, if no selected alarm is active. Equates to quiescent current principle.	And	$A1 \wedge A2$	The relay operates only, if all selected alarms are active.	nAnd	$\overline{A1 \wedge A2} = \overline{A1} \vee \overline{A2}$	As soon as a selected alarm is not activated, the relay operates.
or	$A1 \vee A2$	As soon as a selected alarm is activated, the relay operates. Equates to operating current principle.											
nor	$\overline{A1 \vee A2} = \overline{A1} \wedge \overline{A2}$	The relay operates only, if no selected alarm is active. Equates to quiescent current principle.											
And	$A1 \wedge A2$	The relay operates only, if all selected alarms are active.											
nAnd	$\overline{A1 \wedge A2} = \overline{A1} \vee \overline{A2}$	As soon as a selected alarm is not activated, the relay operates.											
	<p>Alarms for relay 1, COM-1: Default: <i>A.1</i></p> <p>COM-1 P A.1 ▲▼ A.2 ▲▼ A.1234 P</p> <p>The allocation of the alarms to relay 1 happens via this parameter, one alarm or a group of alarms can be chosen. With [P] the selection is confirmed and the device changes into menu level.</p>												

Menu level	Parameterisation level
	<p>Back to menu group level, <i>RET</i>:</p> <p>With [P] the selection is confirmed and the device changes into menu group level „- REL -“.</p>

5.4.7. Alarm parameters

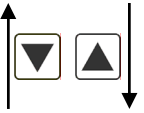

Menu level	Parameterisation level
	<p>Dependency alarm1, ALRM.1: Default: <i>ACTUA</i></p> <p>  </p> <p>The dependency of alarm 1 can be related to special functions, in detail these are the current measuring value, the min-value, the max-value. With [P] the selection is confirmed and the device changes into menu level.</p> <p>Example: By using the maximum value <i>ALARM.1 = MAXVA</i> in combination with a threshold monitoring <i>FU-1 = HIGH</i>, an alarm confirmation can be realised. Use the navigationkeys, the fourth key or the digital input for confirmation.</p>
	<p>Threshold values / Limit values, LI-1: Default: <i>200.0</i></p> <p>  </p> <p>The limit value defines the threshold, that activates/deactivates an alarm.</p>
	<p>Hysteresis for threshold values, HY-1: Default: <i>0.0</i></p> <p>  </p> <p>The delayed reaction of the alarm is the difference to the threshold value, which is defined by the hysteresis.</p>

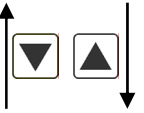
Menu level	Parameterisation level
	<p>Function for threshold value undercut /exceedance, <i>FU-1</i>: Default: <i>HIGH</i></p> <p></p> <p>A limit value undercut is selected with <i>LOW</i> (for LOW = lower limit value), a limit value exceedance with <i>HIGH</i> (for HIGH = higher limit value). If e.g. limit value 1 is on a threshold level of 100 and allocated with function <i>HIGH</i>, an alarm is activated by reaching of the threshold level. If the threshold value was allocated to <i>LOW</i>, an alarm will be activated by undercutting the threshold value, as long as the hysteresis is zero.</p>
	<p>Switching-on delay, <i>TON-1</i>: Default: <i>000</i></p> <p></p> <p>For limit value 1 one can preset a delayed switching-on of 0-100 seconds.</p>
	<p>Switching-off delay, <i>TOF-1</i>: Default: <i>000</i></p> <p></p> <p>For limit value 1 one can preset a delayed switching-off of 0-100 seconds.</p>
	<p>Back to menu group level, <i>RET</i>:</p> <p>With [P] the selection is confirmed and the device changes into menu group level „- <i>AL1</i> -“.</p>

The same applies for *AL2* to *AL8*.

Programming interlock, *RUN*:

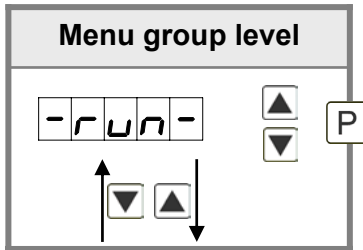

Description see page 8, menu level *RUN*

6. Reset to default values

To return the unit to a **defined basic state**, a reset can be carried out to the default values.

The following procedure should be used:

- Switch off the power supply
- Press button [P]
- Switch on voltage supply and press [P]-button until „- - - -“ is shown in the display.

With reset, the default values of the program table are loaded and used for subsequent operation. This sets the unit back to the state in which it was supplied.

Caution! All application-related data are lost.

7. Alarms / Relays

This device has 8 virtual alarms that can monitor one limit value in regard of an undercut or exceedance. Each alarm can be allocated to an optional relay output S1-S2; furthermore alarms can be controlled by events like e.g. min-/max-value.

Function principle of alarms / relays	
Alarm / Relay x	deactivated, instantaneous value or an allocation via the min-/max-value
Switching threshold	Threshold / limit value of the change-over
Hysteresis	Broadness of the window between the switching thresholds
Working principle	Operating current / quiescent current

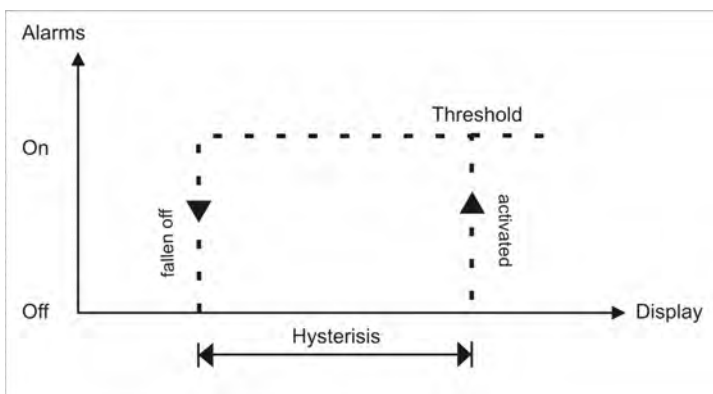

Operating current

By operating current the alarm S1-S2 is off below the threshold and on on reaching the threshold.

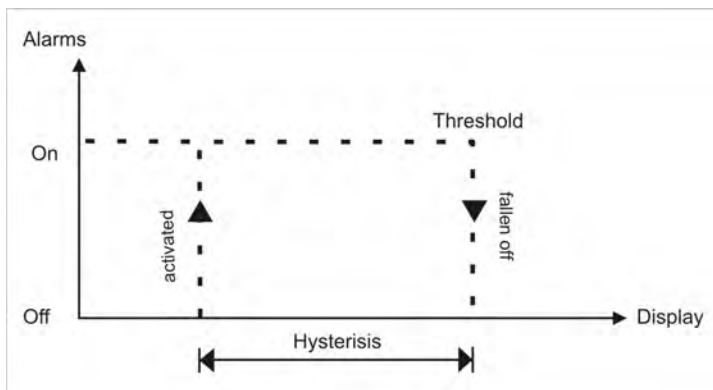

Quiescent current

By quiescent current the alarm S1-S2 is on below the threshold and switched off on reaching the threshold.

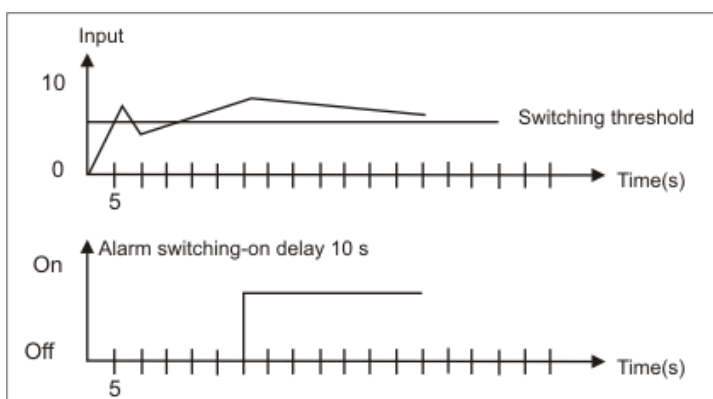

Switching-on delay

The switching-on delay is activated via an alarm and e.g. switched 10 seconds after reaching the switching threshold, a short-term exceedance of the switching value does not cause an alarm, respectively does not cause a switching operation of the relay. The switching-off delay operates in the same way, keeps the alarm / the relay switched longer for the parametrised time.

8. Interfaces

Connection RS232

Digital meter M3

PC - 9-pole Sub-D-plug



Connection RS485

Digital meter M3

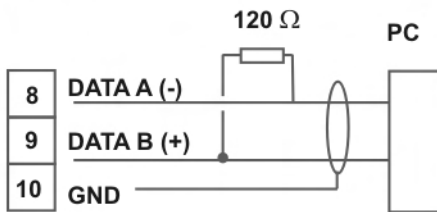

The interface **RS485** is connected via a screened data line with twisted wires (Twisted-Pair). On each end of the bus segment a termination of the bus lines needs to be connected. This is necessary to ensure a secure data transfer to the bus. For this a resistance (120 Ohm) is interposed between the lines Data B (+) and Data A (-).

9. Technical data

Housing			
Dimensions	96x24x120 mm (BxHxD)		
	96x24x144 (154) mm (BxHxD) incl. plug-in terminal		
Panel cut-out	92.0 ^{+0.8} x 22.2 ^{+0.3} mm		
Wall thickness	up to 10 mm		
Fixing	screw elements		
Material	PC polycarbonate, black, UL94V-0		
Sealing material	EPDM, 65 Shore, black		
Protection class	standard IP65 (front), IP00 (back side)		
Weight	approx. 200 g		
Connection	plug-in terminal; wire cross-section up to 2.5 mm ²		
Display			
Digit height	14 mm		
Segment colour	red (optional green, orange or blue)		
Range of display	-19999 to 99999		
Setpoint	one LED per setpoint		
Overflow	horizontal bars at the top		
Underflow	horizontal bars at the bottom		
Display time	0.1 to 10.0 seconds		
Input	Measuring range	Measuring error	Digit
Type L (Fe-CuNi alter Typ)	-200.0...-900.0°C	2 K	±1
Type J (Fe-CuNi)	-210.0...1200.0°C	2 K	±1
Type K (NiCr-NiAL)	-270.0...1372.0°C	2 K	±1
Type B (Pt30Rh-Pt6Rh)	80.0...1820.0°C	2 K	±1
Type S (Pt10Rh-Pt)	-50.0...1768.0°C	2 K	±1
Type N (NiCrSi-NiSi)	-270.0...1300°C	2 K	±1
Type E (NiCr-CuNi)	-270.0...1000.0°C	2 K	±1
Type T (Cu-Cu-Ni)	-270.0...400.0°C	2 K	±1
Type R (Pt13Rh-Pt)	-50.0...1768.0°C	2 K	±1
Characteristic line error	< ±1		
Reference junction	Thermistor		

Accuracy	
Drift of temperature	100 ppm / K
Measuring time	0.1...10.0 seconds
Measuring principle	U/F-conversion
Resolution	0.1°C or 0.1°F
Output	
Analog output	0/4-20 mA / burden ≤500 Ohm, 0-10 VDC / burden ≥10 kOhm, 16 Bit
Switching outputs	
Relay with change-over contact Switching cycles	250 VAC / 5 AAC; 30 VDC / 5 ADC 0.5 x 10 ⁵ at contact load 0.5 x 10 ⁶ mechanically Division according to DIN EN 50178 / Characteristics according to DIN EN 60255
Interface	
Protocol	Modbus with ASCII or RTU-protocol
RS232	9.600 Baud, no parity, 8 Databit, 1 Stopbit, cable length max. 3 m
RS485	9.600 Baud, no parity, 8 Databit, 1 Stopbit, cable length max. 1000 m
Power supply	
	100-240 VAC 50/60 Hz / DC +/- 10% (max. 10 VA) 10-40 VDC galv. isolated, 18-30 VAC 50/60 Hz (max. 10 VA)
Memory	
	EEPROM
Data life	≥ 100 years / 25°C
Ambient conditions	
Working temperature	0°C...50°C
Storing temperature	-20°C...80°C
Wheathering resistance	relative humidity 0-80% on years average without dew
EMV	
	EN 61326
CE-sign	
	conformity according to directive 2004/108/EG
Safety standard	
	according to low voltage directive 2006/95/EG EN 61010; EN 60664-1

10. Safety advices

Please read the following safety advice and the assembly *chapter 2* before installation and keep it for future reference.

Proper use

The **M3-3T-device** is designed for the evaluation and display of sensor signals.



Danger! Careless use or improper operation can result in personal injury and/or damage to the equipment.

Control of the device

The panel meters are checked before dispatch and sent out in perfect condition. Should there be any visible damage, we recommend close examination of the packaging. Please inform the supplier immediately of any damage.

Installation

The **M3-3T-device** must be installed by a suitably **qualified specialist** (e.g. with a qualification in industrial electronics).

Notes on installation

- There must be no magnetic or electric fields in the vicinity of the device, e.g. due to transformers, mobile phones or electrostatic discharge.
- The **fuse rating** of the supply voltage should not exceed a value of **6A N.B. fuse**.
- Do not install **inductive consumers** (relays, solenoid valves etc.) near the device and **suppress** any interference with the aid of RC spark extinguishing combinations or free-wheeling diodes.
- Keep input, output and supply lines separate from one another and do not lay them parallel with each other. Position “go” and “return lines” next to one another. Where possible use twisted pair. So, you receive best measuring results.
- Screen off and twist sensor lines. Do not lay current-carrying lines in the vicinity. Connect the **screening on one side** on a suitable potential equaliser (normally signal ground).
- The device is not suitable for installation in areas where there is a risk of explosion.
- Any electrical connection deviating from the connection diagram can endanger human life and/or can destroy the equipment.
- The terminal area of the devices is part of the service. Here electrostatic discharge needs to be avoided. Attention! High voltages can cause dangerous body currents.
- Galvanic insulated potentials within one complex need to be placed on an appropriate point (normally earth or machines ground). So, a lower disturbance sensibility against impacted energy can be reached and dangerous potentials, that can occur on long lines or due to faulty wiring, can be avoided.

11. Error elimination

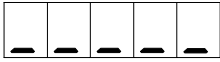
	Error description	Measures
1.	<p>The unit permanently indicates overflow.</p> 	<ul style="list-style-type: none"> • The input has a very high measurement, check the measuring circuit. • The input is open
2.	<p>The unit permanently shows underflow.</p> 	<ul style="list-style-type: none"> • The input has a very low measurement, check the measuring circuit . • The input is open
3.	<p>The word "HELP" lights up in the 7-segment display.</p>	<ul style="list-style-type: none"> • The unit has found an error in the configuration memory. Perform a reset on the default values and re-configure the unit according to your application.
4.	<p>Program numbers for parameterising of the input are not accessible.</p>	<ul style="list-style-type: none"> • Programming lock is activated • Enter correct code
5.	<p>"ERR" lights up in the 7-segment display</p>	<ul style="list-style-type: none"> • Please contact the manufacturer if errors of this kind occur.
6.	<p>The device does not react as expected.</p>	<ul style="list-style-type: none"> • If you are not sure that the device has been para-meterised before, then follow the steps as written in <i>chapter 6</i> and set it back to its delivery status.