User manual M3

Frequency input: 0.01 Hz to 999.99 kHz

Connection for Namur-, NPN-, PNP- and TTL-sensors



Technical features:

- red display of -19999...99999 digits (optional: green, orange or blue display)
- minimal installation depth: 90 mm without plug-in terminal
- min-/max memory
- adjustment via factory default or directly on the sensor signal
- 30 adjustable supporting points
- display flashing at threshold undercut or exceedance
- Schmitt-trigger-input
- zero-key for triggering of Hold, Tara
- permanent min-/max-value recording
- digital frequency filter for contact bounce suppression and interference suppression
- frequency filter with varying pulse-duty factor
- volume metering (totaliser) for frequencies up to 1 kHz (accurate to a pulse)
- mathematical function like reciprocal value, square root, rounding
- sliding averaging with an optional dynamic display filter
- setpoint generator
- brightness control
- programming interlock via access code
- protection class IP65 at the front
- plug-in terminal
- option: sensor supply
- option: galv. insulated digital input
- option: PhotoMos-outputs
- option: analog output
- accessories: PC-based configuration-kit PM-TOOL incl. CD & USB.adapter for devices without keypad and for a simple adjustment of standard devices

Identification

STANDARD TYPES	ORDER NUMBER
Frequency	M3-7FR5A.0007.S70BD
Housing size: 48x24 mm	M3-7FR5A.0007.770BD

Options – breakdown of order code:

M 3 - 7 F R 5 A . 0 0 0 7 . 7 7 2 B D	
Standard type M-Line	Dimension D physical unit
Installation depth incl. plug-in terminal 109 mm	Version B B
Housing size B48xH24xD90 mm	Switching points 0 no switching point 2 2 PhotoMos-outputs
Display type Frequency	Protection class 1 without keypad, operation on the back 7 IP65 / plug-in terminal
Display colour Blue Green Red Yellow	Voltage supply 7 24 VDC, galv. insulated S 100-240 VAC
Number of digits 5-digit	Measuring input 7 0.01 Hz - 999.99 kHz
Digit height 10 mm	Analog output 0 none X 0-10 VDC, 0/4-20 mA
Digital input none 1 digital input	Sensor supply 0 none 3 24 VDC / 50 mA incl. digital input K 24 VDC / 50 mA incl. digital input and pulse output (10 kHz)

Please state physical unit by order, e.g. m/min.

Contents

1.	Brief description	2
2.	Assembly	3
3.	Electrical connection	4
4.	Function description and operation	6
	4.1. Programming software PM-TOOL	7
5.	Setting up the device	8
	5.1. Switching on	8
	5.2. Standard parameterisation (flat operation level)	8
	Value assignment for the triggering of the signal input	
	5.3. Programming interlock „RUN“	12
	Activation/Deactivation of the programming interlock or change into professional or flat operation level	
	5.4. Extended parameters (professional operation level)	13
	5.4.1. Signal input parameters „INP“	13
	Value assignment for the triggering of the signal input incl. linearisation	
	5.4.2. General device parameters „FCT“	17
	Superior device functions like Hold, Tara, min/max permanent, setpoint value function / nominal value function, averaging, brightness control, as well as the control of the digital input and keyboard layout	
	5.4.3. Safety parameters „COD“	21
	Assignment of user and master code to lock or to receive access to defined parameter such as analog output and alarms, etc.	
	5.4.4. Analog output parameters „OUT“	22
	Analog output functions	
	5.4.5. Relay functions „REL“	24
	Parameter for setpoint definition	
	5.4.6. Alarm parameters „AL1...AL4“	26
	Actuator and dependencies of the alarms	
	5.4.7. Totaliser (Volume metering) „TOT“	28
	Parameter for calculation of the sum function	
6.	Reset to factory settings	29
	Reset parameters onto the delivery state	
7.	Alarms / Relays	30
	Functional principle of the switching outputs	
8.	Programmer examples	31
	Sample applications such as e.g. calculation of the input frequency or the adjustment at unknown rotation speed	
9.	Technical data	33
10.	Safety advices	35
11.	Error elimination	36

1. Brief description

The panel meter instrument **M3-7F** is a 5-digit device for pulse signals, respectively 2- and 3-wire sensors. The configuration happens via three keys at the front. The integrated programming interlock prevents unrequested changes of parameters and can be unlocked again with an individual code. Optional the following functions are available: a supply for the sensor, a digital input for triggering of Hold (Tara), one analog output or switching outputs for further evaluating in the unit.

The electrical connection is done via plug-in terminals on the back side.

Selectable functions like e.g. the recall of the min/max-value, an averaging of the measuring signals, a nominal presetting or setpoint presetting, digital frequency filter for contact bounce suppression and disturbance suppression with adjustable key relation, a direct threshold value regulation during operation mode and further measuring setpoints for linearisation, complete the modern device concept.

2. Assembly

Please read the *Safety advices* on page 35 before installation and keep this user manual for future reference.

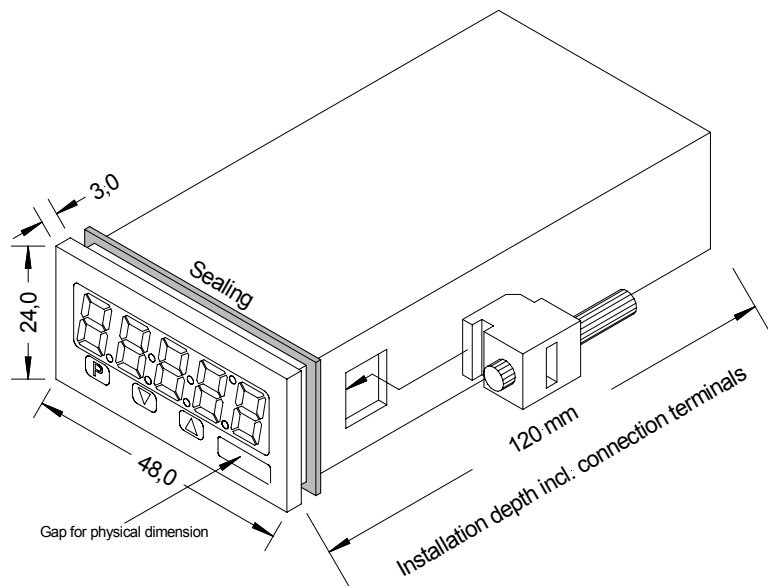

1. After removing the fixing elements, insert the device.
2. Check the seal to make sure it fits securely.
3. Click the fixing elements back into place and tighten the clamping screws by hand. Then use a screwdriver to tighten them another half a turn.

CAUTION! The torque should not exceed 0.1 Nm!

Change signs of the physical unit before assembly via a channel at the side of the front! The change can only be done from the outside before assembly!

3. Electrical connection

Type M3-7FR5A.0007.S70BD with a supply of 100-240 VAC

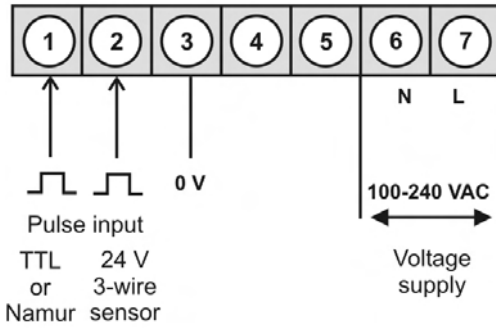

Options:

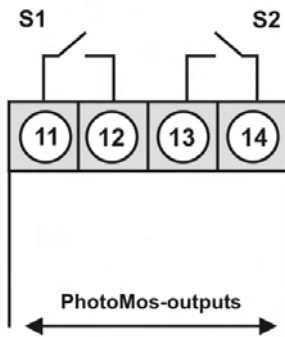

Type M3-7FR5A.0007.770BD with a supply of 24 VDC

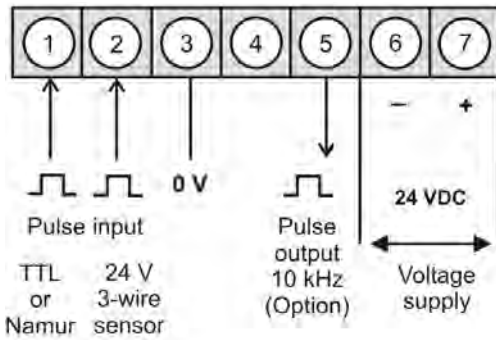

Options:

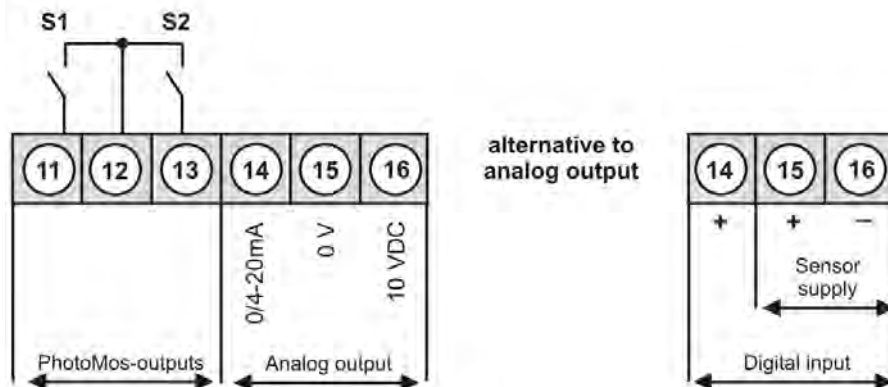

M3-devices

Below you find some connection examples with practical applications:

Namur

lower terminal

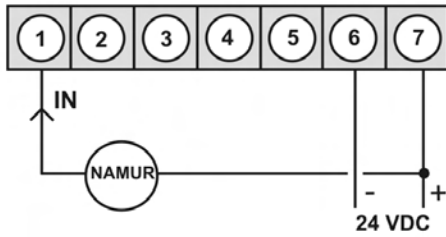

Namur

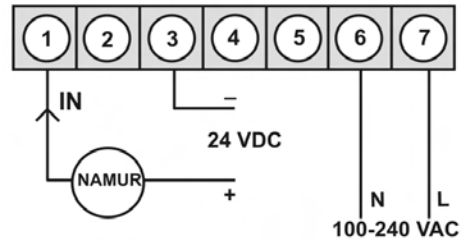

3-wire PNP

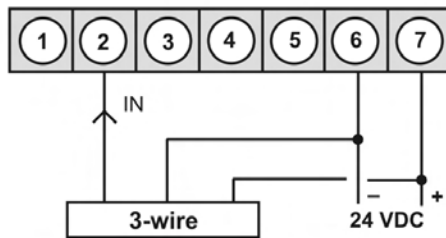

3-wire PNP

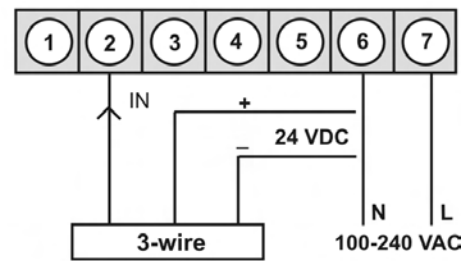

3-wire NPN

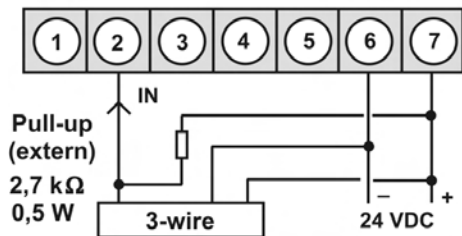

3-wire NPN

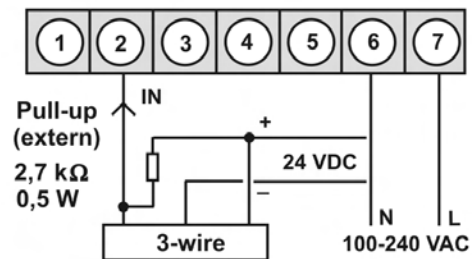

M3 with digital input in combination with 24 VDC sensor supply

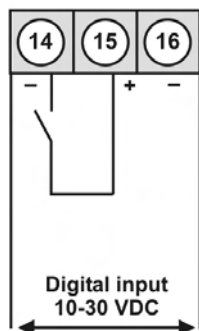

M3 with digital input and external voltage source

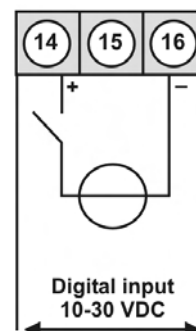

4. Function- and operation description

Operation

The operation is divided into three different levels.

Menu level (delivery status)













This level is for the standard settings of the device. Only menu items which are sufficient to set the device into operation are displayed. To get into the professional level, run through the menu level and parameterise "*PROF*" under menu item *RUN*.

Menu group level (complete function volume)

Suited for complex applications as e.g. linkage of alarms, setpoint treatment, totaliser function etc. In this level function groups which allow an extended parameterisation of the standard settings are available. To leave the menu group level, run through this level and parameterise „*ULOC*„ under menu item *RUN*.

Parameterisation level:

Parameter deposited in the menu item can here be parameterised. Functions, that can be changed or adjusted, are always signalled by a flashing of the display. Settings that are made in the parameterisation level are confirmed with **[P]** and thus safed. By pressing the „zero-key“ it leads to a break-off of the value input and to a change into the menu level. All adjustments are safed automatically by the device and changes into operating mode, if no further key operation is done within the next 10 seconds.

Level	Key	Description
Menu level		Change to parameterisation level and deposited values.
	 	Keys for up and down navigation in the menu level.
		Change into operation mode.
Parameterisation level		To confirm the changes made at the parameterization level.
	 	Adjustment of the value / the setting.
		Change into menu level or break-off in value input.
Menu group level		Change to menu level.
	 	Keys for up and down navigation in the menu group level.
		Change into operation mode or back into menu level.

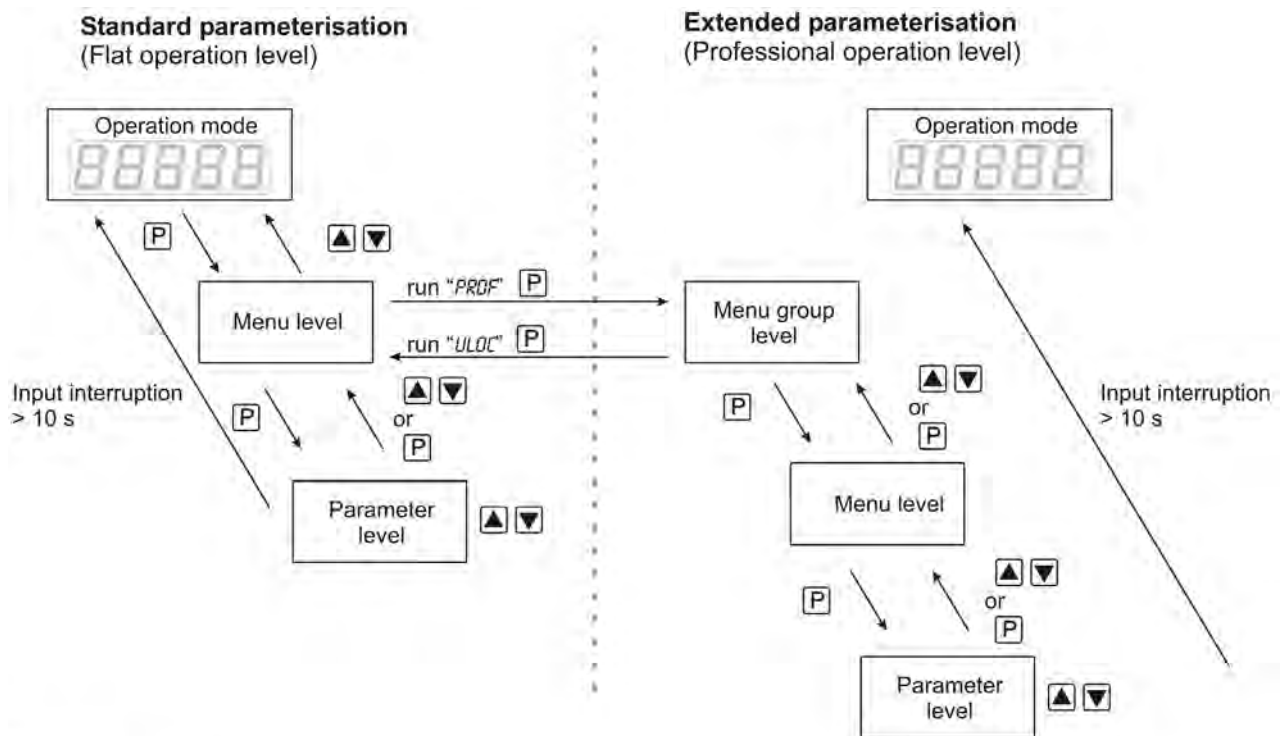
Function chart:**Explanation:**

- P Take-over
- ▲▼ Breakoff by simultaneously pushing of the navigation keys
- ▲ Value selection (+)
- ▼ Value selection (-)

4.1. Parameterisation software PM-TOOL:

Part of the PM-TOOL are the software on CD and an USB-cable with device adapter. The connection is done via a 4-pole micromatch-plug on the back side of the device, to the PC-side the connection ist done via an USB plug.

System requirements: PC incl. USB interface
Software: Windows XP, Windows VISTA

With this tool the device configuration can be generated, omitted and safed on the PC. The parameters can be changed via the easy to handle program surface, wherent the operating mode and the possible selection options can be preset by the program.

5. Setting up the device

5.1. Switching-on





Once the installation is complete, you can start the device by applying the voltage supply. Before, check once again that all electrical connections are correct.





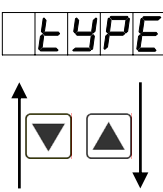

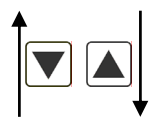
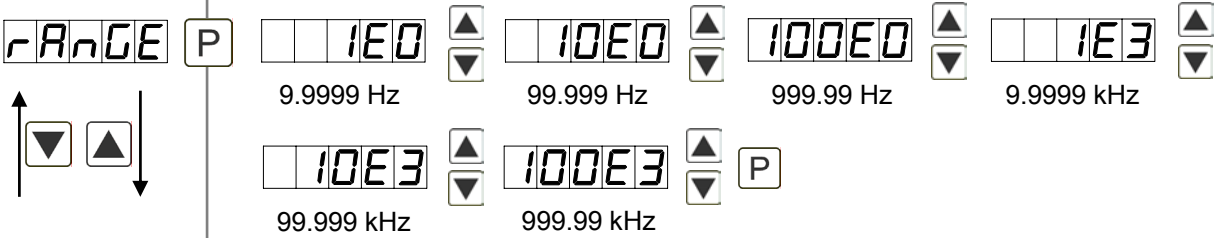
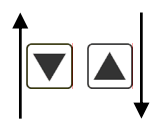

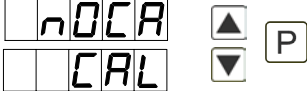

Starting sequence

For 1 second during the switching-on process, the segment test (θ θ θ θ θ) is displayed, followed by an indication of the software type and, after that, also for 1 second, the software version. After the starting sequence, the device switches to operation/display mode.

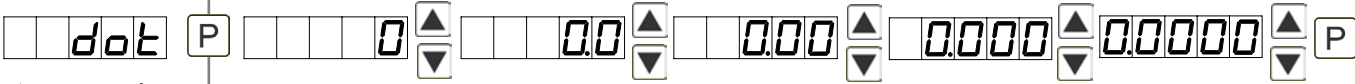

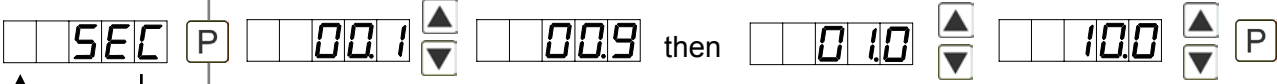



5.2. Standard parameterisation: (flat operation level)

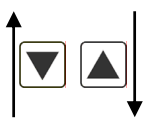
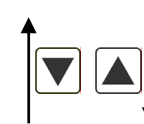
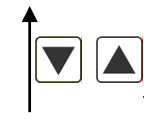
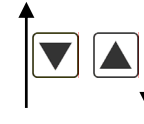
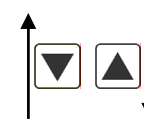



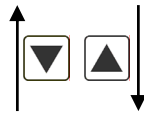

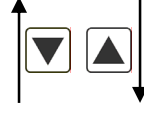
To parameterize the display, press the **[P]** key in operating mode for 1 second. The display then changes to the menu level with the first menu item **TYPE**.

Menu level	Parameterisation level
	<p>Selection of the input signal, TYPE: Default: <i>FREQU</i></p>  <p>If the scaling of the device is done via <i>SENS.F</i> (Sensor calibration), the frequency range needs to be preset under <i>RANGE</i> and is adjusted by application of the final value /initial value. If <i>FREQU</i> (Factory calibration) is preferred, the final value needs to be entered under <i>END</i> and the final frequency needs to be entered under <i>ENDR</i>. Under <i>OFFS</i> the initial value needs to be entered and under <i>OFFSA</i> the initial frequency. There is no application of the measuring signal. Confirm the selection with [P] and the display switches back to menu level.</p>
	<p>Setting end value of the measuring range, END: Default: <i>100E3</i></p>  <p>Choose between six different frequency ranges. Confirm the selection with [P] and the display switches back to menu level.</p>
	<p>Setting the final value of the measuring range, END: Default: <i>10000</i></p>  <p>Set the final value from the smallest to the highest digit with [▲] [▼] and confirm each digit with [P]. A minus sign can only be parametrized on the highest value digit. After the last digit, the display switches back to the menu level. If <i>SENS</i> was selected as input option, you can only select between <i>NOCA</i> and <i>CAL</i>. With <i>NOCA</i>, only the previously set display value is taken over, and with <i>CAL</i>, the device takes over both the display value and the analogue input value.</p>

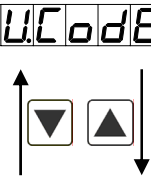
Menu level	Parameterisation level
	<p>Setting the start/offset value of the measuring range, <i>OFFS</i>: Default: 0</p> <p>   </p> <p>Enter the start/offset value from the smallest to the highest digit [▲] [▼] and confirm each digit with [P]. After the last digit the display switches back to the menu level. If <i>SENS.F</i> was selected as the input option, you can only select between <i>NOCA</i> and <i>CAL</i>. With <i>NOCA</i>, only the previously set display value is taken over, and with <i>CAL</i>, the device takes over both the display value and the analogue input value.</p>
	<p>Setting the decimal point, <i>DOT</i>: Default: 0</p> <p>  </p> <p>The decimal point on the display can be moved with [▲] [▼] and confirmed with [P]. The display then switches back to the menu level again.</p>
	<p>Setting up the display time, <i>SEC</i>: Default: 1.0</p> <p>  </p> <p>The display time is set with [▲] [▼]. The display moves up in increments of 0.1 sec up to 1 sec and in increments of 1.0 sec up to 10.0 sec. Confirm the selection by pressing the [P] button. The display then switches back to the menu level again.</p>
	<p>Rescaling the measuring input values, <i>ENDR</i>: Default: 10000</p> <p>  </p> <p>With this function, you can rescale the input value of e.g. 8.000 Hz (works setting) without applying a measuring signal. If sensor calibration has been selected, these parameters are not available.</p>
	<p>Rescaling the measuring input values, <i>OFFA</i>: Default: 0</p> <p>  </p> <p>With this function, you can rescale the input value of e.g. 100 Hz (works setting) without applying a measuring signal. If sensor calibration has been selected, these parameters are not available.</p>

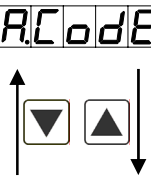
Menu level	Parameterisation level
<p>DELAY P</p> 	<p>Setting of the pulse delay, DELAY: Default: 0</p> <p>0 250 P</p> <p>With the impulse delay of 0 – 250 s (max), frequencies can be collected, which are even smaller than by the predetermined measuring time of the device. If e.g. a delay of 250 seconds is set, this means that the device waits up to 250 seconds for an edge, before it assumes a 0 Hz-frequency. Thus frequencies up to 0.004 Hz can be collected.</p>
<p>FI.Frq P</p> 	<p>Adjustment of the optimum digital frequency filter, FI.FRQ: Default: NO</p> <p>no 100 50 20 10 5 2 P</p> <p>If the optional filter is not activated by the adjustment „NO“, frequencies are ignored by the adjusted frequency filter. Act on the assumption that the pulse-duty factor is 1:1. Accordingly the minimal pulse duration is derived from the half of the time of oscillation. Use a filter of 10 Hz or 20 Hz for contact bounce suppression.</p>
<p>Out.rA P</p> 	<p>Selection of analog output, OUT.RA: Default: 4-20</p> <p>0-10 0-20 4-20 P</p> <p>Three output signals are available: 0-10 VDC, 0-20 mA and 4-20 mA, with this function, the demanded signal is selected.</p>
<p>Out.En P</p> 	<p>Setting up the final value of the analog output, OUT.EN: Default: 10000</p> <p>8 P 8 P 8 P 8 P 8 P</p> <p>The final value is adjusted from the smallest digit to the highest digit with [▲] [▼] and digit by digit confirmed with [P]. A minus sign can only be parameterised on the highest digit. After the last digit, the device changes back into menu level.</p>
<p>Out.OF P</p> 	<p>Setting up the initial value of the analog output, OUT.OF: Default: 00000</p> <p>8 P 8 P 8 P 8 P 8 P</p> <p>The final value is adjusted from the smallest digit to the highest digit with [▲] [▼] and digit by digit confirmed with [P]. A minus sign can only be parameterised on the highest digit. After the last digit, the device changes back into menu level.</p>

Menu level	Parameterisation level
	<p>Threshold values / limit values, LI-1: Default: 2000</p> <p>LI-1 P 0 P 0 P 0 P 0 P 0 P</p> <p>For both limit values, two different values can be parameterized. With this, the parameters for each limit value are called up one after another.</p>
	<p>Hysteresis for limit values, HY-1: Default: 00000</p> <p>HY-1 P 0 P 0 P 0 P 0 P 0 P</p> <p>For all limit values exists a hysteresis function, that reacts according to the settings (threshold exceedance / threshold undercut).</p>
	<p>Function if display falls below / exceeds limit value, FU-1: Default: HIGH</p> <p>FU-1 P HIGH LOW P</p> <p>The limit value undercut can be selected with <i>LOW</i> (LOW = lower limit value) and limit value exceedance can be selected with <i>HIGH</i> (HIGH = upper limit value). If e.g. limit value 1 is on a switching threshold of 100 and occupied with function „<i>HIGH</i>“, the alarm will be activated by reaching the threshold. If the limit value is allocated to „<i>LOW</i>“, an alarm will be activated by undercut of the threshold. See page 29.</p>
	<p>Threshold values / Limits, LI-2: Default: 3000</p> <p>LI-2 P 0 P 0 P 0 P 0 P 0 P</p> <p>This value defines the threshold, that activates/deactivates an alarm.</p>
	<p>Hysteresis for limit values, HY-2: Default: 00000</p> <p>HY-2 P 0 P 0 P 0 P 0 P 0 P</p> <p>The delayed reaction of the alarm is the difference to the threshold value, which is defined by the hysteresis.</p>
	<p>Function for threshold value undercut /exceedance, FU-2: Default: HIGH</p> <p>FU-2 P HIGH LOW P</p> <p>A limit value undercut is selected with <i>LOW</i> (for LOW = lower limit value), a limit value exceedance with <i>HIGH</i> (for HIGH = higher limit value). If e.g. limit value 1 is on a threshold level of 100 and allocated with function <i>HIGH</i>, an alarm is activated by reaching of the threshold level. If the threshold value was allocated to <i>LOW</i>, an alarm will be activated by undercutting the threshold value, as long as the hysteresis is zero.</p>





Menu level	Parameterisation level
	<p>User code (4-digit number-combination, free available), <i>U.CODE</i>: Default: 0000</p>  <p>If this code is set (>0000), all parameters are locked, if <i>LOC</i> has been selected before under menu item <i>RUN</i>. By pushing [P] during operation mode for approx. 3 seconds, <i>CODE</i> appears in the display. To get to the unlocked reduced parameter, the user needs to enter the preset <i>U.CODE</i>. This code has to be entered before each parameterisation, until the <i>A.CODE</i> (Master code) unlocks all parameters again.</p>
	<p>Master code (4-digit number-combination free available), <i>A.CODE</i>: Default: 1234</p>  <p>With this code, all parameters can be unlocked, if <i>LOC</i> has been activated before under menu item <i>RUN</i>. By pushing [P] during operation mode for approx. 3 seconds, <i>CODE</i> appears in the display. The user can now reach all parameters by entering <i>A.CODE</i>. Leaving the parameterisation, under menu item <i>RUN</i>, the user can unlock them permanently by choosing <i>ULOC</i> or <i>PROF</i>. So, there is no need for anew code entering, even by pushing [P] during operation mode again.</p>
<p>5.3. Programming interlock „RUN“</p>	
	<p>Activation / deactivation of the programming lock or completion of the standard parameterization with change into menu group level (complete function range), <i>RUN</i>: Default: <i>ULOC</i></p>  <p>With the navigation keys [▲] [▼], you can choose between the deactivated key lock <i>ULOC</i> (works setting) and the activated key lock <i>LOC</i>, or the menu group level <i>PROF</i>. Confirm the selection with [P]. After this, the display confirms the settings with "- - - -", and automatically switches to operating mode. If <i>LOC</i> was selected, the keyboard is locked. To get back into the menu level, press [P] for 3 seconds in operating mode. Now enter the <i>CODE</i> (works setting 1 2 3 4) that appears using [▲] [▼] plus [P] to unlock the keyboard. <i>FAIL</i> appears if the input is wrong.</p> <p>To parameterise further functions <i>PROF</i> needs to be set. The device confirms this setting with „- - - -“, and changes automatically in operation mode. By pressing [P] for approx. 3 seconds in operation mode, the first menu group <i>INP</i> is shown in the display and thus confirms the change into the extended parameterisation. It stays activated as long as <i>ULOC</i> is entered in menu group <i>RUN</i>, thus the display is set back in standard parameterisation again.</p>

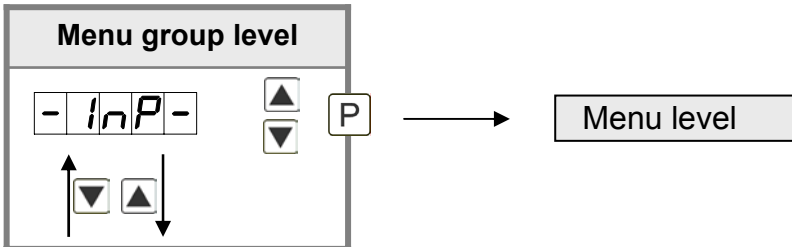



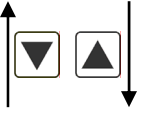

5.4. Extended parametrisation (Professional operation level)





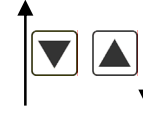
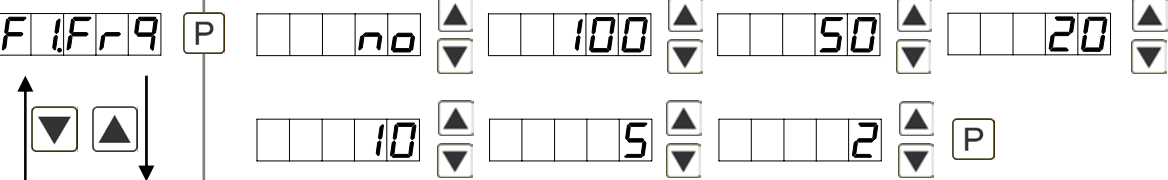
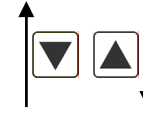
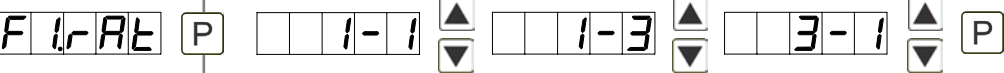





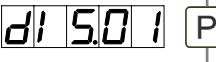









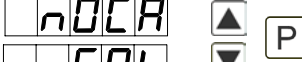
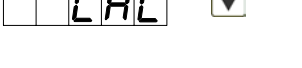

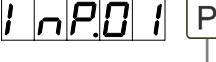









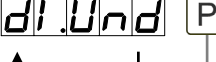









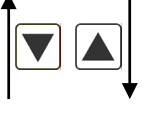
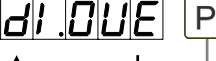

5.4.1. Signal input parameters



Menu level	Parameterisation level
	<p>Selection of the input signal, TYPE: Default: <i>FREQU</i></p> <p>TYPE P SENS.F FREQU P</p> <p>If the scaling of the device is done via <i>SENS.F</i> (Sensor calibration), the frequency range needs to be preset under <i>RANGE</i> and is adjusted by application of the final value /initial value. If <i>FREQU</i> (Factory calibration) is preferred, the final value needs to be entered under <i>END</i> and the final frequency needs to be entered under <i>ENDR</i>. Under <i>OFFS</i> the initial value needs to be entered and under <i>OFFSA</i> the initial frequency. There is no application of the measuring signal. Confirm the selection with [P] and the display switches back to menu level.</p>
	<p>Setting the end value of the measuring range, END: Default: <i>100E3</i></p> <p>RANGE P 9.9999 Hz 99.999 Hz 999.99 Hz 9.9999 kHz</p> <p>10E3 100E3 P</p> <p>99.999 kHz 999.99 kHz</p> <p>Choose between six different frequency ranges. Confirm the selection with [P] and the display switches back to menu level.</p>
	<p>Setting the final value of the measuring range, END: Default: <i>10000</i></p> <p>End P 8 P 8 P 8 P 8 P 8 NOCR CAL P</p> <p>Set the final value from the smallest to the largest digit with [▲] [▼] and confirm each digit with [P]. A minus sign can only be parameterized on the highest value digit. After the last digit, the display switches back to the menu level. If <i>SENS</i> was selected as input option, you can only select between <i>NOCR</i> and <i>CAL</i>. With <i>NOCR</i>, only the previously set display value is taken over, and with <i>CAL</i>, the device takes over both the display value and the analogue input value.</p>

Menu level	Parameterisation level
	<p>Setting the start/offset value of the measuring range, OFFS: Default: 0</p> <p>OFFS P 8 P 8 P 8 P 8 P 8 ▲ ▼ nOCA ▲ P CAL ▼ P</p> <p>Enter the start/offset value from the smallest to the highest digit [▲] [▼] and confirm each digit with [P]. After the last digit the display switches back to the menu level. If <i>SENS.F</i> was selected as the input option, you can only select between <i>nOCA</i> and <i>CAL</i>. With <i>nOCA</i>, only the previously set display value is taken over, and with <i>CAL</i>, the device takes over both the display value and the analogue input value.</p>
	<p>Setting the decimal point, DOT: Default: 0</p> <p>dot P 0 ▲ ▼ 00 ▲ ▼ 0.00 ▲ ▼ 0.000 ▲ ▼ 000000 ▲ ▼ P</p> <p>The decimal point on the display can be moved with [▲] [▼] and confirmed with [P]. The display then switches back to the menu level again.</p>
	<p>Setting up the display time, SEC: Default: 1.0</p> <p>SEC P 00.1 ▲ ▼ 00.9 then 0.10 ▲ ▼ 10.0 ▲ ▼ P</p> <p>The display time is set with [▲] [▼]. The display moves up in increments of 0.1 sec up to 1 sec and in increments of 1.0 sec up to 10.0 sec. Confirm the selection by pressing the [P] button. The display then switches back to the menu level again.</p>
	<p>Rescaling the measuring input values, ENDA: Default: 10000</p> <p>EndA P 8 P 8 P 8 P 8 P 8 ▲ ▼ P</p> <p>With this function, you can rescale the input value of e.g. 8.000 Hz (works setting) without applying a measuring signal. If sensor calibration has been selected, these parameters are not available.</p>
	<p>Rescaling the measuring input values, OFFA: Default: 0</p> <p>OFFSA P 8 P 8 P 8 P 8 P 8 ▲ ▼ P</p> <p>With this function, you can rescale the input value of e.g. 100 Hz (works setting) without applying a measuring signal. If sensor calibration has been selected, these parameters are not available.</p>

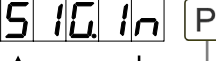
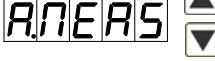
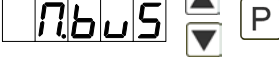





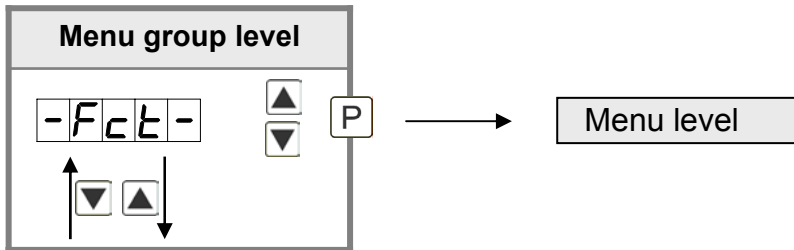



Menu level	Parameterisation level
	<p>Setting up the pulse delay, DELAY: Default: 0</p> <p></p> <p>With the pulse delay of 0 – 250 s (max), frequencies can be collected, which are even smaller than by the predetermined measuring time of the device. If e.g. a delay of 250 seconds is set, this means that the device waits up to 250 seconds for an edge, before it assumes a 0 Hz-frequency. Thus frequencies up to 0.004 Hz can be collected.</p>
	<p>Adjustment of the optimum digital frequency filter, FI.FREQ: Default: NO</p> <p></p> <p>If the optional filter is not activated by the adjustment „NO“, frequencies are ignored by the adjusted frequency filter. Act on the assumption that the pulse-duty factor is 1:1. Accordingly the minimal pulse duration is derived from the half of the time of oscillation. Use a filter of 10 Hz or 20 Hz for contact bounce suppression.</p>
	<p>Adjustment of the pulse-duty factor at activated digital filter, FI.RAT: Default: 1</p> <p></p> <p>Adjustment of the desired pulse-duty factor for pulse duration and pulse interruption. Like this, a special pulse behaviour can be adjusted.</p>
	<p>Setting up the tare/offset value, TARA: Default: 0</p> <p></p> <p>The given value is added to the linearized value. In this way, the characteristic line can be shifted by the selected amount.</p>
	<p>Number of additional setpoints, SPCT: Default: 00</p> <p></p> <p>30 additional setpoints can be defined to the initial- and final value, so linear sensor values are not linearised. Only activated setpoint parameters are displayed.</p>

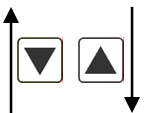



Menu level	Parameterisation level
	<p>Display values for setpoints, DIS.01 ... DIS.30:</p> <p>           </p> <p>   </p> <p>Under this parameter setpoints are defined according to their value. At the sensor calibration, like at Final value/Offset, one is asked at the end if a calibration shall be activated.</p>
	<p>Analog values for setpoints, INP.01 ... INP.30:</p> <p>           </p> <p>These setpoints are displayed at works setting (4-20 mA) only. Here, demanded analog values can be chosen freely. The input of steadily rising analog values needs to be done self-contained.</p>
	<p>Display underflow, DI.UND: Default: -19999</p> <p>           </p> <p>With this function the device undercut (_____) can be defined on a definite value.</p>
	<p>Display overflow, DI.OUE: Default: 99999</p> <p>           </p> <p>With this function the display overflow (-----) can be defined on a definite value.</p>
	<p>Input variable of process value, SIG.IN: Default: A.MEAS</p> <p>    </p> <p>This parameter controls the device via the analog input signals <i>A.MEAS</i> = <i>SENS.F</i> respectively <i>FRE9U</i> or via the digital signals of the interface <i>n.BUS</i> = RS232/RS485 (Modbus protocol). Confirm the selection with [P] and the device changes back into menu level.</p>
	<p>Back to menu group level, RET:</p> <p>With [P] the selection is confirmed and the device changes into menu group level „-IMP-“.</p>

5.4.2. General device parameters



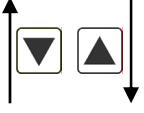

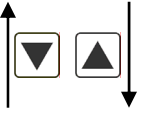



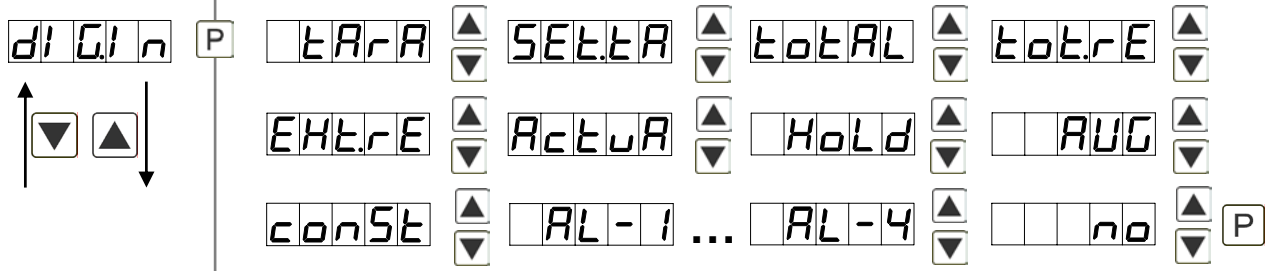
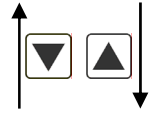



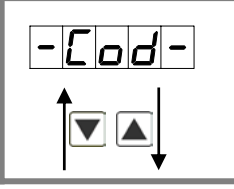
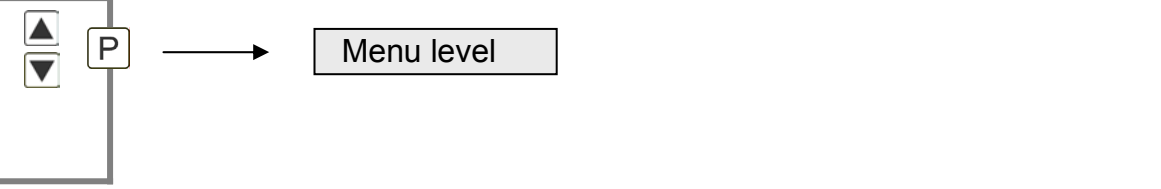
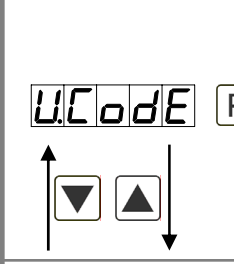

Menu level	Parameterisation level
<p>di.SEC P</p> <p>▲ ▼</p> <p>▲ ▼</p>	<p>Display time, <i>DISEC</i>: Default: 01.0</p> <p>00.1 ▲ ▼ then 0.10 ▲ ▼ 10.0 ▲ ▼ P</p> <p>The display is set up with [▲] [▼]. Thereby on switches until 1 second in 0.1 steps and until 10.0 seconds in 1.0-steps. With [P] the selection is confirmed and the device changes into menu level.</p>
<p>round P</p> <p>▲ ▼</p> <p>▲ ▼</p>	<p>Rounding of display values, <i>ROUND</i>: Default: 00001</p> <p>00001 ▲ ▼ 00005 ▲ ▼ 00010 ▲ ▼ 00050 ▲ ▼ P</p> <p>This function is for instable display values, where the display value is changed in 1-, 5-, 10- or 50-steps. This does not affect the resolution of the optional outputs. With [P] the selection is confirmed and the device changes into menu level.</p>
<p>Arith P</p> <p>▲ ▼</p> <p>▲ ▼</p>	<p>Arithmetic, <i>ARITH</i>: Default: NO</p> <p>no ▲ ▼ rE2IP ▲ ▼ rAdIC ▲ ▼ SQUAR ▲ ▼ P</p> <p>Reciprocal Root extraction Square</p> <p>With this function the calculated value, not the measuring value, is shown in the display. With NO, no calculation is deposited. With [P] the selection is confirmed and the device changes into menu level.</p>
<p>AUG P</p> <p>▲ ▼</p> <p>▲ ▼</p>	<p>Sliding average determination, <i>AVG</i>: Default: 10</p> <p>001 ▲ ▼ 100 ▲ ▼ P</p> <p>Here, the number of the meterings that need to be averaged is preset. The time of averaging results of the product of measuring time SEC and the averaged metering AVG. With the selection of AVG in the menu level DISPL, the result will be shown in the display and evaluated via the alarms.</p>

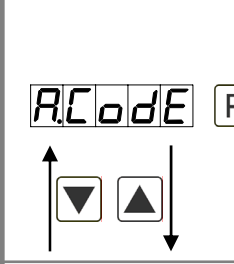
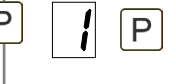
Menu level	Parameterisation level
	<p>Dynamic for the sliding average determination, <i>STEP</i>: Default: <i>NO</i></p> <p></p> <p>With <i>STEP</i> the sliding average determination can be adjusted dynamically. If 6pro or 12pro is selected, a frequency value with a variance of 6% or 12% of the current display value is taken over directly for the sliding averaging. The display appears to be more dynamic at a fast frequency change, without appearing disturbed by a slightly unsteady frequency.</p>
	<p>Zero point slowdown, <i>ZERO</i>: Default: <i>00</i></p> <p></p> <p>At the zero point slowdown, a value range around the zero point can be preset, so the display shows a zero. If e.g. a 10 is set, the display would show a zero in the value range from -10 to +10; below continue with -11 and beyond with +11.</p>
	<p>Definite constant value, <i>CONST</i>: Default: <i>0</i></p> <p></p> <p>The constant value can be evaluated via the alarms or via the analog output, like the current measurand. The decimal place cannot be changed for this value and is taken over by the current measurand. Like this a setpoint generator can be realised via the analog output by this value. Furthermore it can be used for calculating the difference. At this the constant value is subtracted from the current measurand and the difference is evaluated in the alerting or by the analog output. Thus regulations can be displayed quite easily.</p>
	<p>Minimum constant value, <i>CON.MI</i>: Default: <i>-9999</i></p> <p></p> <p>The minimum constant value is adjusted from the smallest to the highest digit with the navigation keys [▲] [▼] and confirmed digit per digit with [P]. A minus sign can only be adjusted on the highest digit. After the last digit the display changes back into menu level.</p>
	<p>Maximum constant value, <i>CON.MA</i>: Default: <i>99999</i></p> <p></p> <p>The maximum constant value is adjusted from the smallest to the highest digit with the navigation keys [▲] [▼] and confirmed digit per digit with [P]. A minus sign can only be adjusted on the highest digit. After the last digit the display changes back into menu level.</p>

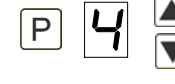
Menu level	Parameterisation level
	<p>Display, <i>DISPL</i>: Default: <i>ACTUA</i></p> <p><i>di SPL</i> [P] <i>ActuA</i> ▲▼ <i>mi nUA</i> ▲▼ <i>MAxUA</i> ▲▼ <i>to tAL</i> ▲▼ <i>HoLD</i> ▲▼ <i>AUG</i> ▲▼ <i>conSt</i> ▲▼ <i>dIFF</i> ▲▼ [P]</p> <p>With this function the current measuring value, min-/max value, totaliser value, the process-controlled Hold-value, the sliding average value, the constant value or the difference between constant value and current value can be allocated to the display. With [P] the selection is confirmed and the device changes into menu level.</p>
	<p>Brightness control, <i>LIGHT</i>: Default: <i>15</i></p> <p><i>LIGHE</i> [P] <i>00</i> ▲▼ <i>15</i> ▲▼ [P]</p> <p>The brightness of the display can be adjusted in 16 levels from 00 = very dark to 15 = very bright via this parameter or alternatively via the navigation keys from the outside. During the start of the device the level that is deposited under this parameter will always be used, even though the brightness has been changed via the navigation keys in the meantime.</p>
	<p>Display flashing, <i>FLASH</i>: Default: <i>NO</i></p> <p><i>FLASH</i> [P] <i>no</i> ▲▼ <i>AL-1</i> ▲▼ <i>AL-2</i> ▲▼ <i>AL12</i> ▲▼ <i>AL-3</i> ▲▼ <i>AL-4</i> ▲▼ <i>AL34</i> ▲▼ <i>ALAL</i> ▲▼ [P]</p> <p>A display flashing can be added as additional alarm function either to single or to a combination of off-limit condition. With <i>NO</i>, no flashing is allocated.</p>
	<p>Assignment (deposit) of key functions, <i>TAST</i>: Default: <i>NO</i></p> <p><i>TAST</i> [P] <i>EHTR</i> ▲▼ <i>LI.12</i> ▲▼ <i>LI.34</i> ▲▼ <i>TARA</i> ▲▼ <i>SEt.tA</i> ▲▼ <i>to tAL</i> ▲▼ <i>to t.rE</i> ▲▼ <i>EHT.rE</i> ▲▼ <i>ActuA</i> ▲▼ <i>LIGHE</i> ▲▼ <i>no</i> ▲▼ [P]</p> <p>For the operation mode, special functions can be deposited on the navigation keys [▲] [▼], in particular this function is made for devices in housing size 48x24 which do not have a 4th key ([IO] key). If the min-/max-memory is activated with <i>EHTR</i>, all measured min/max-values are safed during operation and can be recalled via the navigation keys. The values get lost by restart of the device. If the threshold value correction <i>LI.12</i> or <i>LI.34</i> is choosen, the values of the threshold can be changed during operation without disturbing the operating procedure. With <i>TARA</i> the device is tared to zero and safed permanently as offset. The device confirms the correct taring by showing <i>00000</i> in the display. <i>SEt.tA</i> switches into the offset value and can be changed via the navigation keys [▲] [▼].</p>

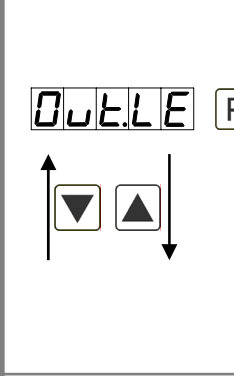
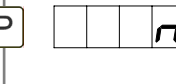
Menu level	Parameterisation level
<p>Continuation</p>	<p>Via TOTAL the current value of the totaliser can be displayed for approx.7 seconds, after this the device changes back on the parameterised display value. If TOT.RE is deposited, the totaliser can be set back by pressing of the navigation keys [▲] [▼], the device acknowledges this with 00000 in the display. The configuration of EHT.RE deletes the MIN/MAX-memory. Under ACTUA the measurand is shown for approx. 7 seconds, after this the display returns to the parameterised display value. The brightness can be adjusted with LIGHT. This adjustment is not safed and lost at a restart of the device. If NO is selected, the navigation keys are without any function in the operation mode.</p>
	<p>Special function [O]-key, TAST.4: Default: NO</p>  <p>For the operation mode, special functions can be deposited on the digital input. This function is activated by pressing the key. With TARA the device is set temporarily on a parameterised value. The device acknowledges the correct taring with 00000 in the display. SET.TA adds a defined value on to the currently displayed value. Via TOTAL the current value of the totaliser can be displayed for approx. 7 seconds, after this the device switches back on the parameterised display value. If TOT.RE is deposited, the totaliser can be set back by pressing of the navigation keys [▲] [▼], the device acknowledges this with 00000 in the display. EHT.RE deletes the min/max-memory. If HOLD has been selected, the moment can be hold constant by triggering the digital input, and is updated by releasing the key. Advice: HOLD is activated only, if HOLD is selected under parameter DISPL. ACTUA shows the measuring value for approx. 7 seconds, after this the device switches back on the parameterised display value. The same goes for AVG, here the sliding average values will be displayed. The constant value CONST can be recalled via the digital input, or changed digit per digit. At AL-1...AL-4 an output can be set and therewith e.g. a setpoint adjustment can be done. If NO is selected, the digital input is without any function in the operation mode.</p>
	<p>Back to menu group level, RET:</p> <p>With [P] the selection is confirmed and the device changes into menu group level „- FCT -“.</p>

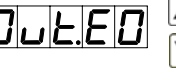
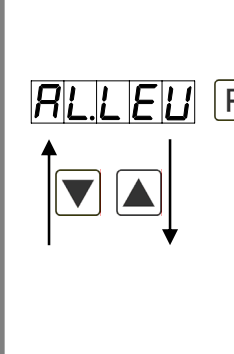
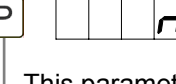

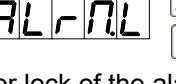
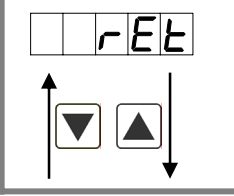
5.4.3. Safety parameters

Menu group level	
	
Menu level	Parameterisation level
	<p>User code, <i>U.CODE</i>: Default: 0000</p>     <p>Via this code reduced sets of parameters can be set free. A change of the <i>U.CODE</i> can be done via the correct input of the <i>A.CODE</i> (master code).</p>
	<p>Master code, <i>A.CODE</i>: Default: 1234</p>     <p>By entering <i>A.CODE</i> the device will be unlocked and all parameters are released.</p>
	<p>Release/lock analog output parameters, <i>OUT.LE</i>: Default: ALL</p>     <p>Analog output parameter can be locked or released for the user:</p> <ul style="list-style-type: none"> - At <i>EN-OF</i> the initial or final value can be changed in operation mode. - At <i>OUT.EO</i> the output signal can be changed from e.g. 0-20 mA to 4-20 mA or 0-10 VDC. - At <i>ALL</i> analog output parameters are released. - At <i>NO</i> all analog output parameters are locked.
	<p>Release/lock alarm parameters, <i>AL.LEU</i>: Default: ALL</p>     <p>This parameter describes the user release/user lock of the alarm.</p> <ul style="list-style-type: none"> - <i>LIMIT</i>, here only the range of value of the threshold values 1-4 can be changed. - <i>ALRM.L</i>, here the range of value and the alarm trigger can be changed. - <i>ALL</i>, all alarm parameters are released. - <i>NO</i>, all alarm parameters are locked.
	<p>Back to menu group level, <i>RET</i>:</p> <p>With [P] the selection is confirmed and the device changes into menu group level „- COD -“.</p>

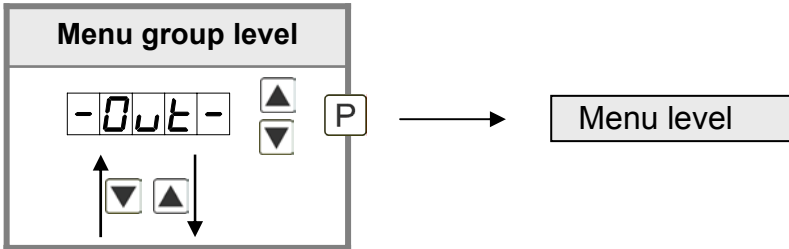
5.4.4. Analog output parameters



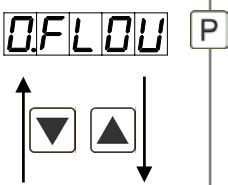

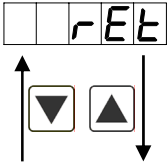
Menu level	Parameterisation level
<p>OutPt P</p> <p>↑ ↓</p>	<p>Selection reference of analog output, <i>OUTPT</i>: Default: <i>ACTUA</i></p> <p>ACTUA ▲ ▼ MINUA ▲ ▼ MAXUA ▲ ▼ TOTAL ▲ ▼ HOLD ▲ ▼ AVG ▲ ▼ const ▲ ▼ dIFF ▲ ▼ P</p> <p>The analog output signal can refer to different functions, in detail these are the current measurand, the min-value, the max-value, the totaliser-/sum function, the constant value or the difference between current measurand and constant value. If <i>HOLD</i> is selected, the signal of the analog output will be kept. It can be continued processing after a deactivation of <i>HOLD</i>. With [P] the selection is confirmed and the device changes into menu level.</p>
<p>Out.rA P</p> <p>↑ ↓</p>	<p>Selection analog output, <i>OUT.RA</i>: Default: <i>4-20</i></p> <p>0-10 ▲ ▼ 0-20 ▲ ▼ 4-20 ▲ ▼ P</p> <p>Three output signals are available 0-10 VDC, 0-20 mA and 4-20 mA. Select the desired signal with this function.</p>
<p>Out.En P</p> <p>↑ ↓</p>	<p>Setting the final value of the analog output, <i>OUT.EN</i>: Default: <i>10000</i></p> <p>8 P 8 P 8 P 8 P 8 ▲ ▼ P</p> <p>The final value is adjusted from the smallest to the highest digit with [▲] [▼] and confirmed digit per digit with [P]. A minus sign can only be parameterised on the highest digit. After the last digit the device changes back into menu level.</p>
<p>Out.OF P</p> <p>↑ ↓</p>	<p>Setting the initial value of the analog output, <i>OUT.OF</i>: Default: <i>00000</i></p> <p>8 P 8 P 8 P 8 P 8 ▲ ▼ P</p> <p>The initial value is adjusted from the smallest to the highest digit with [▲] [▼] and confirmed digit per digit with [P]. A minus sign can only be parameterised on the highest digit. After the last digit the device changes back into menu level.</p>

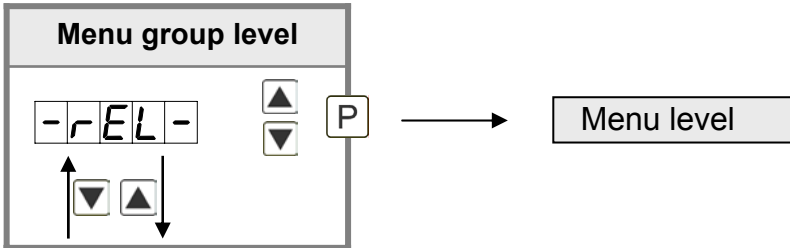

Menu level	Parameterisation level
	<p>Overflow behaviour, O.FLOU: Default: <i>EDGE</i></p> <p>  </p> <p>To recognise and evaluate faulty signals, e.g. by a controller, the overflow behaviour of the analog output can be defined. As overflow can be seen either <i>EDGE</i>, that means the analog output runs on the set limits e.g. 4 and 20 mA, or <i>TO.OFF</i> (input value smaller than initial value, analog output switches on e.g. 4 mA), <i>TO.END</i> (higher than final value, analog output switches on e.g. 20 mA). If <i>TO.MIN</i> or <i>TO.MAX</i> is set, the analog output jumps on the smallest or highest possible binary value. This means that values of e.g. 0 mA, 0 VDC or values higher than 20 mA or 10 VDC can be reached. With [P] the selection is confirmed and the device changes into menu level.</p>
	<p>Back to menu group level, RET:</p> <p>With [P] the selection is confirmed and the device changes into menu group level „- OUT -“.</p>

5.4.5. Relay functions





Menu level	Parameterisation level												
<p>REL-1 P</p> <p>Navigation arrows</p>	<p>Alarm relay 1, REL-1: Default: <i>AL-1</i></p> <p>AL-1 AL-4 ▲▼ AL-n1 AL-n4 ▲▼</p> <p>LOGIC ▲▼ OFF ▲▼ On ▲▼ P</p> <p>Each setpoint (optional) can be linked up via 4 alarms (by default). This can either be inserted at activated alarms <i>AL1/4</i> or de-activated alarms <i>ALn1/4</i>. If <i>LOGIC</i> is selected, logical links are available in the menu level <i>LOG-1</i> and <i>COM-1</i>. One can only get to these two menu levels via <i>LOGIC</i>, at all other selected functions, these two parameters are overleaped. Via <i>ON/OFF</i> the setpoints can be activated/de-activated, in this case the output and the setpoint display are set/not set on the front of the device. With [P] the selection is confirmed and the device changes into menu level.</p>												
<p>LOG-1 P</p> <p>Navigation arrows</p>	<p>Logic relay 1, LOG-1: Default: <i>OR</i></p> <p>or ▲▼ nor ▲▼ And ▲▼ nAnd ▲▼ P</p> <p>Here, the switching behaviour of the relay is defined via a logic link, the following schema describes these functions with inclusion of <i>AL-1</i> and <i>AL-2</i>:</p> <table border="1"> <tbody> <tr> <td>or</td> <td>$A1 \vee A2$</td> <td>As soon as a selected alarm is activated, the relay operates. Equates to operating current principle.</td> </tr> <tr> <td>nor</td> <td>$\overline{A1 \vee A2} = \overline{A1} \wedge \overline{A2}$</td> <td>The relay operates only, if no selected alarm is active. Equates to quiescent current principle.</td> </tr> <tr> <td>And</td> <td>$A1 \wedge A2$</td> <td>The relay operates only, if all selected alarms are active.</td> </tr> <tr> <td>nAnd</td> <td>$\overline{A1 \wedge A2} = \overline{A1} \vee \overline{A2}$</td> <td>As soon as a selected alarm is not activated, the relay operates.</td> </tr> </tbody> </table> <p>With [P] the selection is confirmed and the device changes into menu level.</p>	or	$A1 \vee A2$	As soon as a selected alarm is activated, the relay operates. Equates to operating current principle.	nor	$\overline{A1 \vee A2} = \overline{A1} \wedge \overline{A2}$	The relay operates only, if no selected alarm is active. Equates to quiescent current principle.	And	$A1 \wedge A2$	The relay operates only, if all selected alarms are active.	nAnd	$\overline{A1 \wedge A2} = \overline{A1} \vee \overline{A2}$	As soon as a selected alarm is not activated, the relay operates.
or	$A1 \vee A2$	As soon as a selected alarm is activated, the relay operates. Equates to operating current principle.											
nor	$\overline{A1 \vee A2} = \overline{A1} \wedge \overline{A2}$	The relay operates only, if no selected alarm is active. Equates to quiescent current principle.											
And	$A1 \wedge A2$	The relay operates only, if all selected alarms are active.											
nAnd	$\overline{A1 \wedge A2} = \overline{A1} \vee \overline{A2}$	As soon as a selected alarm is not activated, the relay operates.											





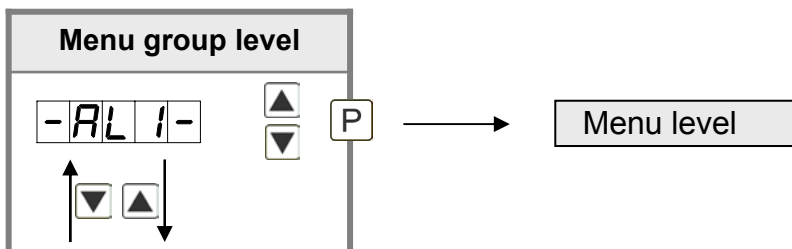

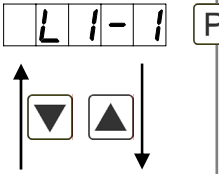

Menu level	Parameterisation level												
	<p>Alarms for relay 1, COM-1: Default: <i>A.1</i></p> <p>COM-1 [P] A.1 [▲] [▼] A.2 [▲] [▼] A.1234 [P]</p> <p>The allocation of the alarms to relay 1 happens via this parameter, one alarm or a group of alarms can be chosen. With [P] the selection is confirmed and the device changes into menu level.</p>												
	<p>Alarm relay 2, REL-2: Default: <i>AL-2</i></p> <p>REL-2 [P] AL-1 AL-4 [▲] [▼] AL-n1 AL-n4 [▲] [▼]</p> <p>LOGIC [▲] [▼] OFF [▲] [▼] On [▲] [▼] [P]</p> <p>Each setpoint (optional) can be linked up via 4 alarms (by default). This can either be inserted at activated alarms <i>AL2/4</i> or de-activated alarms <i>ALN2/4</i>. If <i>LOGIC</i> is selected, logical links are available in the menu level <i>LOG-1</i> and <i>COM-1</i>. One can only get to these two menu levels via <i>LOGIC</i>, at all other selected functions, these two parameters are overleaped. Via <i>ON/OFF</i> the setpoints can be activated/de-activated, in this case the output and the setpoint display are set/not set on the front of the device. With [P] the selection is confirmed and the device changes into menu level.</p>												
	<p>Logic relay 2, LOG-2: Default: <i>OR</i></p> <p>LOG-2 [P] or [▲] [▼] nor [▲] [▼] And [▲] [▼] nAnd [▲] [▼] [P]</p> <p>Here, the switching behaviour of the relay is defined via a logic link, the following schema describes these functions with inclusion of <i>AL-1</i> and <i>AL-2</i>:</p> <table border="1"> <tbody> <tr> <td>or</td> <td>$A1 \vee A2$</td> <td>As soon as a selected alarm is activated, the relay operates. Equates to operating current principle.</td> </tr> <tr> <td>nor</td> <td>$\overline{A1 \vee A2} = \overline{A1} \wedge \overline{A2}$</td> <td>The relay operates only, if no selected alarm is active. Equates to quiescent current principle.</td> </tr> <tr> <td>And</td> <td>$A1 \wedge A2$</td> <td>The relay operates only, if all selected alarms are active.</td> </tr> <tr> <td>nAnd</td> <td>$\overline{A1 \wedge A2} = \overline{A1} \vee \overline{A2}$</td> <td>As soon as a selected alarm is not activated, the relay operates.</td> </tr> </tbody> </table> <p>With [P] the selection is confirmed and the device changes into menu level.</p>	or	$A1 \vee A2$	As soon as a selected alarm is activated, the relay operates. Equates to operating current principle.	nor	$\overline{A1 \vee A2} = \overline{A1} \wedge \overline{A2}$	The relay operates only, if no selected alarm is active. Equates to quiescent current principle.	And	$A1 \wedge A2$	The relay operates only, if all selected alarms are active.	nAnd	$\overline{A1 \wedge A2} = \overline{A1} \vee \overline{A2}$	As soon as a selected alarm is not activated, the relay operates.
or	$A1 \vee A2$	As soon as a selected alarm is activated, the relay operates. Equates to operating current principle.											
nor	$\overline{A1 \vee A2} = \overline{A1} \wedge \overline{A2}$	The relay operates only, if no selected alarm is active. Equates to quiescent current principle.											
And	$A1 \wedge A2$	The relay operates only, if all selected alarms are active.											
nAnd	$\overline{A1 \wedge A2} = \overline{A1} \vee \overline{A2}$	As soon as a selected alarm is not activated, the relay operates.											

Menu level	Parameterisation level
	<p>Alarms for relay 2, CON-2: Default: A. 2</p> <p>CON-2 P A.1 A.2 ... A.1234 P</p> <p>The allocation of the alarms for relay 5 happens via this parameter, one alarm or a group of alarms can be chosen. With [P] the selection is confirmed and the device changes into menu level.</p>
	<p>Back to menu group level, RET:</p> <p>RET</p> <p>With [P] the selection is confirmed and the device changes into menu group level „- REL -“.</p>

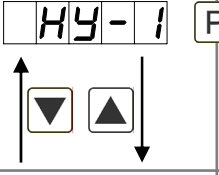
5.4.6. Alarm parameters

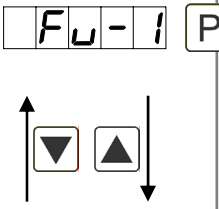
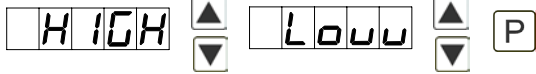
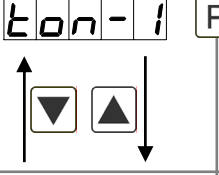

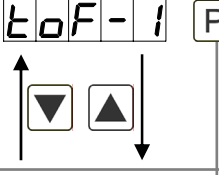
Menu level	Parameterisation level
	<p>Dependency alarm1, ALRM.1: Default: ACTUA</p> <p>ALRM.1 P ActUA MINUA MAXUA totAL</p> <p>HoLd AUG conSt dIFF</p> <p>EHTER P</p> <p>The dependency of alarm 1 can be related to special functions, in detail these are the current measuring value, the MIN-value, the MAX-value, the totaliser-/sum-value, the constant value or the difference between the current measurand and the constant value. Is HOLD selected, then the alarm is hold and processed just after deactivation of HOLD. EHTER causes the dependency either by pressing the [O]-key on the front of the housing or by an external signal via the digital input. With [P] the selection is confirmed and the device changes into menu level.</p> <p>Example: By using the maximum value ALARM.1 = MAX.VA in combination with a threshold monitoring FU-1 = HIGH, an alarm confirmation can be realised. Use the navigationkeys, the fourth key or the digital input for confirmation.</p>

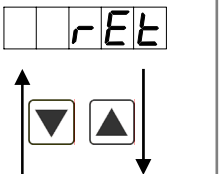
Menu level	Parameterisation level
	<p>Threshold values / limit values, LI-1: Default: 2000</p>  <p>For both limit values, two different values can be parameterized. With this, the parameters for each limit value are called up one after another.</p>
	<p>Hysteresis for limit values, HY-1: Default: 00000</p>  <p>For all limit values exists a hysteresis function, that reacts according to the settings (threshold exceedance / threshold undercut).</p>
	<p>Function if display falls below / exceeds limit value, FU-1: Default: HIGH</p>  <p>The limit value undercut can be selected with LOW (LOW = lower limit value) and limit value exceedance can be selected with HIGH (HIGH = upper limit value). If e.g. limit value 1 is on a switching threshold of 100 and occupied with function „HIGH“, the alarm will be activated by reaching the threshold. If the limit value is allocated to „LOW“, an alarm will be activated by undercut of the threshold.</p>
	<p>Switching-on delay, TON-1: Default: 000</p>  <p>For limit value 1 one can preset a delayed switching-on of 0-100 seconds.</p>
	<p>Switching-off delay, TOF-1: Default: 000</p>  <p>For limit value 1 one can preset a delayed switching-off of 0-100 seconds.</p>
	<p>Back to menu group level, RET:</p> <p>With [P] the selection is confirmed and the device changes into menu group level „- AL1 -“.</p>

The same applies to -AL2- to -AL4-.

5.4.7. Totaliser (Volume measurement)

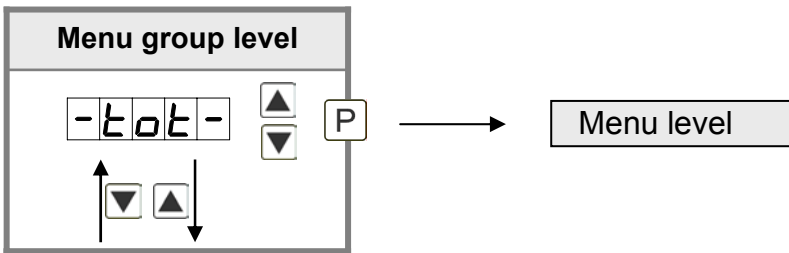

Menu level	Parameterisation level
	<p>Totaliser state, TOTAL: Default: OFF</p> <p>total P OFF STEAD TEMP P</p> <p>The totaliser makes measurements on a time base of e.g. l/h possible, at this the scaled input signal is integrated by a time and steadily (select <i>STEAD</i>) or temporarily (select <i>TEMP</i>) saved. If <i>OFF</i> is selected, the function is de-activated. With [P] the selection is confirmed and the device changes into menu level.</p>
	<p>Time base, T.BASE: Default: SEC</p> <p>tbase P SEC min hour P</p> <p>Under this parameter the time base of the measurement can be preset in seconds, minutes or hours.</p>
	<p>Totaliser factor, FACTO: Default: 10⁰</p> <p>Facto P 10⁰ ... 10⁶ P</p> <p>At this the factor (10⁰...10⁶) respectively the divisor for the internal calculation of the measuring value is assigned.</p>
	<p>Setting up the decimal point for the totaliser, TOT.DT: Default: 0</p> <p>totdt P 0 00 000 0.000 00000 P</p> <p>The decimal point of the device can be adjusted with the navigation keys [▲] [▼]. With [P] the selection is confirmed and the device changes into menu level.</p>

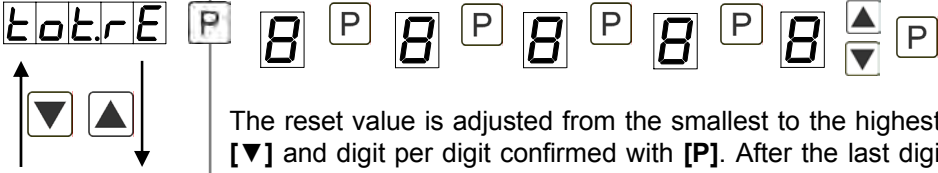
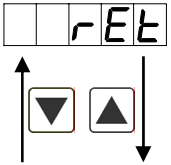
Menu level	Parameterisation level
	<p>Totaliser reset, TOT.RE: Default: 00000</p> <p>The reset value is adjusted from the smallest to the highest digit with the navigation keys [▲] [▼] and digit per digit confirmed with [P]. After the last digit, the display switches back to the menu level. The activator for the reset is parameter driven via the 4th key or via the optional digital input.</p>
	<p>Back to menu group level, RET:</p> <p>With [P] the selection is confirmed and the device changes into menu group level „- TOT -“.</p>

Programming lock, RUN:

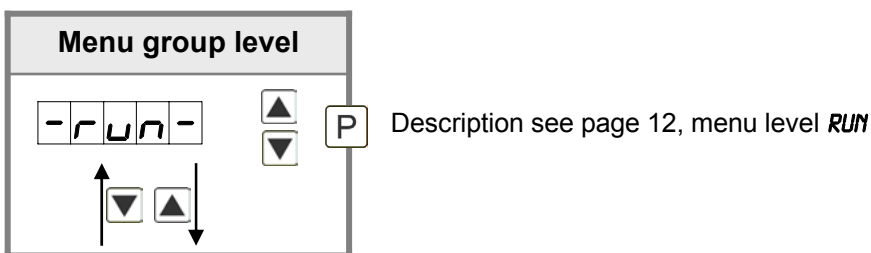

6. Reset to factory settings

To return the unit to a **defined basic state**, a reset can be carried out to the default values. The following procedure should be used:

- Switch off the power supply
- Press button [P]
- Switch on voltage supply and press [P]-button until „- - - - -“ is shown in the display.

With reset, the default values of the program table are loaded and used for subsequent operation. This puts the unit back to the state in which it was supplied.

Caution! All application-related data are lost.

7. Alarms / Relays

This device has 4 virtual alarms that can monitor one limit value in regard of an undercut or exceedance. Each alarm can be allocated to an optional relay output S1-S2; furthermore alarms can be controlled by events like e.g. Hold or min-/max-value.

Function principle of alarms / relays	
Alarm / Relay x	Deactivated, instantaneous value, min-/max-value, Hold-value, totaliser value, sliding average value, constant value, difference between instantaneous value and constant value or an activation via the digital input or via the [O]-key.
Switching threshold	Threshold / limit value of the change-over
Hysteresis	Broadness of the window between the switching thresholds
Working principle	Operating current / Quiescent current

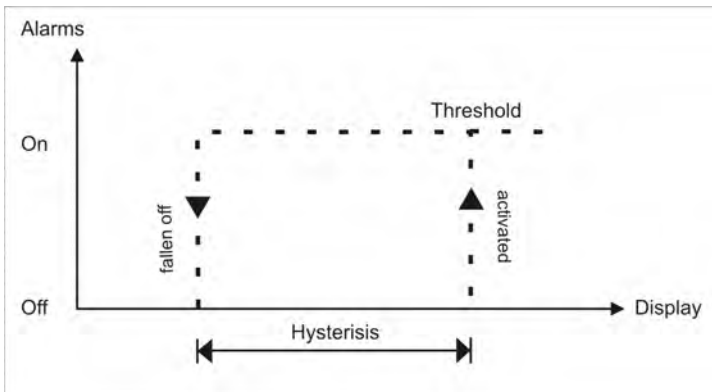

Operating current

By operating current the alarm S1-S2 is off below the threshold and on on reaching the threshold.

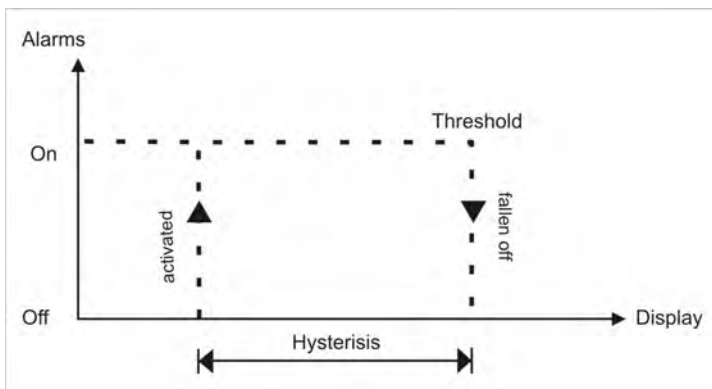

Quiescent current

By quiescent current the alarm S1-S2 is on below the threshold and switched off on reaching the threshold.

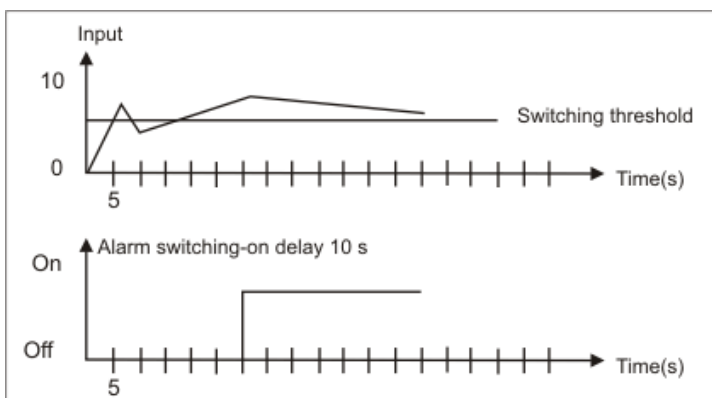

Switching-on delay

The switching-on delay is activated via an alarm and e.g. switched 10 seconds after reaching the switching threshold, a short-term exceedance of the switching value does not cause an alarm, respectively does not cause a switching operation of the relay. The switching-off delay operates in the same way, keeps the alarm / the relay switched longer for the parametrised time.

8. Programmer examples

Examples: Adjustment according to number of sprockets at unknown rotation speed.

- nearly 100% of the rotation speeds are in the range of 0 to 30.000 r.p.m.
- the number of sprockets varies (without gearing) between 1 and 100
- in automation, the frequency supply never exceeds 10 kHz (rather 3 kHz)

Assume a rotation speed of 60 r.p.m. at 1 Hz, whereat the real frequency value will not be considered.

Our example complies with a number of sprockets of 64.

Setting up the advice

Based on the default settings of the display, the following parameters need to be changed:

Parameter	Settings	Description
TYPE	FREQU	Applying of the measuring signal is not applicable.
RANGE	1E3	Complies with 9.9999 Hz
End	6	Assumed final value
EndA	00064	Complies with 64 sprockets

If the frequency needs to be displayed with a position after decimal point, then a 60 has to be selected as final value for this adjustment.

Parameter	Settings	Description
TYPE	FREQU	Applying of the measuring signal is not applicable.
RANGE	1E3	Complies with 9.9999 Hz
End	60	Assumed final value
dot	00	1 position after decimal point
EndA	00064	Complies with 64 sprockets

Example: Rotation speed of a machine shaft

There are 4 sprockets on one machine shaft. Applied in an angle of 90° to each other and to the rotation speed measurement. The sprockets are collected via a proximity switch and evaluated by the frequency device, which shall display the rotation speed in U/min. 0...3600 U/min is preset as rotation speed range of the machine.

Calculation of the input frequency

Number of sprockets = 4
 Rotation speed = 3600 U/min

$$\text{Final frequency [Hz]} = \frac{\text{Final rotation speed } \left[\frac{U}{\text{min}} \right]}{60 \left[\frac{s}{\text{min}} \right] \times 1U} \times \text{Number of sprockets}$$

$$\text{Final frequency [Hz]} = \frac{3600 \frac{U}{\text{min}}}{60 \frac{s}{\text{min}} \times 1U} \times 4 = 240 \text{ Hz}$$

Setting up the device

Based on the default settings of the device, following parameters need to be changed:

Parameter	Settings	Description
TYPE	FREQU	As the input frequency is known, the device does not need to be applied to the measuring section.
RANGE	100E0	The final frequency is in the range of 100.00 to 999.99 Hz.
End	3600	A rotation speed of 3600 shall be displayed as final value.
EndA	240.00	The final frequency for display value 3600 is 24.00 Hz.

9. Technical data

Housing	
Dimensions	48x24x90 mm (BxHxD)
	48x24x109 mm (BxHxD) incl. plug-in terminal
Panel cut-out	45.0 ^{+0.6} x 22.2 ^{+0.3} mm
Wall thickness	up to 5 mm
Fixing	screw elements
Material	PC polycarbonate, black, UL94V-0
Fixing material	EPDM, 65 Shore, black
Protection class	standard IP65 (Front side), IP00 (Back side)
Weight	approx. 200 g
Connection	plug-in terminal; wire-cross section up to 2.5 mm ²
Display	
Digit height	10 mm
Segment colour	red (optional green, orange or blue)
Range of display	-19999 to 99999
Setpoints	one LED per setpoint
Overflow	horizontal bars at the top
Underflow	horizontal bars at the bottom
Display time	0.1 to 10.0 seconds
Input	Measuring range
Transmitter	Namur, 3-wire initiator, pulse input, TTL
High/Low level	> 10 V / < 6 V – U _{in} max. 30 V
TTL level	> 4.6 V / < 1.9 V
Input frequency	0.01 Hz – 999.99 kHz
Input resistance	R _i at 24 V / 4 kΩ / R _i at Namur 1.8 kΩ
Frequency filter	none, 100 Hz, 50 Hz, 20 Hz, 10 Hz, 5 Hz, 2 Hz
Digital input	< 2.4 V OFF, 10 V ON, max. 30 VDC R _i ~ 5 kΩ
Accuracy	
Drift of temperature	50 ppm / K
Measuring time	0.1...10.0 seconds, optional pulse delay of 250 seconds
Measuring principle	Frequency metering / pulse-amplitude metering
Measuring error	0.05 % of measuring range; ± 1 Digit
Resolution	approx. 19 bit per measuring range

Output	
Sensor supply	24 VDC / 50 mA
Pulse output	max. 10 kHz
Analog output	0/4-20 mA / burden 350 Ω or 0-10 VDC / burden 10 k Ω , 16 bit
Switching outputs	
2 PhotoMos (Closer)	Normally open contact: 30 VDC/AC, 0.4 A
Power pack	
	100-240 VAC / 50/60 Hz, DC +/- 10% (max. 5 VA) 24 VDC +/- 10 % galv. insulated (max. 4 A)
Memory	
	EEPROM
Data life	\geq 100 years at 25°C
Ambient conditions	
Working temperature	0...50°C
Storing temperature	-20...80°C
Weathering resistance	relative humidity 0-80% on years average without dew
Height	up to 2000 m over sea level
EMV	
	EN 61326
CE-sign	
	Conformity to directive 2004/108/EG
Safety standard	
	EN 61010; EN 60664-1

10. Safety advices

Please read the following safety advice and the assembly *chapter 2* before installation and keep it for future reference.

Proper use

The **M3-7F-device** is designed for the evaluation and display of sensor signals.



Danger! Careless use or improper operation can result in personal injury and/or damage to the equipment.

Control of the device

The panel meters are checked before dispatch and sent out in perfect condition. Should there be any visible damage, we recommend close examination of the packaging. Please inform the supplier immediately of any damage.



Installation

The **M3-7F-device** must be installed by a suitably **qualified specialist** (e.g. with a qualification in industrial electronics).

Notes on installation

- There must be no magnetic or electric fields in the vicinity of the device, e.g. due to transformers, mobile phones or electrostatic discharge.
- The **fuse rating** of the supply voltage should not exceed a value of **6A N.B. fuse**.
- Do not install **inductive consumers** (relays, solenoid valves etc.) near the device and **suppress** any interference with the aid of RC spark extinguishing combinations or free-wheeling diodes.
- Keep input, output and supply lines separate from one another and do not lay them parallel with each other. Position “go” and “return lines” next to one another. Where possible use twisted pair. So, you receive best measuring results.
- Screen off and twist sensor lines. Do not lay current-carrying lines in the vicinity. Connect the **screening on one side** on a suitable potential equaliser (normally signal ground).
- The device is not suitable for installation in areas where there is a risk of explosion.
- Any electrical connection deviating from the connection diagram can endanger human life and/or can destroy the equipment.
- The terminal area of the devices is part of the service. Here electrostatic discharge needs to be avoided. Attention! High voltages can cause dangerous body currents.
- Galvanic insulated potentials within one complex need to be placed on an appropriate point (normally earth or machines ground). So, a lower disturbance sensibility against impacted energy can be reached and dangerous potentials, that can occur on long lines or due to faulty wiring, can be avoided.

11. Error elimination

	Error description	Measures
1.	The device shows a permanent overflow 	<ul style="list-style-type: none"> The input frequency is too high for the selected frequency range. Correct „<i>RANGE</i>“ according to this. Disturbing pulses lead to an increased input frequency, activate „<i>FI.FRQ</i>“ at smaller frequencies or shield the sensor line. A mechanic switching contact chatters. Activate the frequency filter „<i>FI.FRQ</i>“ with 10 or 20 kHz. The display was taught faulty under „<i>TYPE</i>“ = „<i>SENS.F</i>“. Error elimination see below.
2.	The device shows a permanent underflow. 	<ul style="list-style-type: none"> An offset frequency „<i>OFFSA</i>“ bigger than 0 Hz respectively a „Living Zero“ was selected, in which no frequency is aligned. Check the sensor lines or set the „<i>OFFSA</i>“ onto 0 Hz. The display underflow <i>DL.UND</i> was selected too high. The according parameter needs to be adapted. The device was taught faulty under „<i>TYPE</i>“ = „<i>SENS.F</i>“. Error elimination see below.
3.	The displayed values switches sporadical.	<ul style="list-style-type: none"> Disturbances lead to short-term display switches. For smaller frequencies use the frequency filter „<i>FI.FRQ</i>“, select a higher measuring time or use the sliding averaging. The sprockets that needs to be collected, are not evenly spread on a shaft or are not Use the sliding averaging „<i>AVG</i>“ if necessary with the dynamic function „<i>STEP</i>“. The displayed value „<i>DISPL</i>“ needs to be set on „<i>AVG</i>“.
4.	The display remains on zero.	<ul style="list-style-type: none"> The sensor was not connected properly. Check the connection lines and if necessary the sensor supply. Best directly on the screw terminals of the device! A PNP- respectively NPN-output does not reach the required threshold. Check the voltage between terminal 2 and 3 with a Multimeter. Depending on signal form it generally should be between 4 V and 15 V. The thresholds can be checked more safely with an oscilloscope. If necessary include an external Pull-up or Pull-down. A Namur-sensor does not react. Check the distance between the sensor and the sprocket / survey mark and if necessary measure the voltage between 1 and 3. In open condition the input voltage needs to be smaller than 2.2 V and in active condition bigger than 4.6 V. The selected range of the input frequency is too high. Reduce the frequency range „<i>RANGE</i>“ to a smaller value. The activated frequency filter „<i>FI.FRQ</i>“ suppresses the relevant pulses. Increase the filter frequency „<i>FI.FRQ</i>“ or use the adaption of the key proportion „<i>FI.RAT</i>“. If this should not work, temporarily de-activate the frequency filter with „<i>FI.FRQ</i>“ = „<i>NO</i>“. The device was taught faulty under „<i>TYPE</i>“ = „<i>SENS.F</i>“. Change into „<i>TYPE</i>“ „<i>FREQU</i>“ and preset the assumed frequency range „<i>RANGE</i>“ and the according initial and final values „<i>END</i>“, „<i>OFFS</i>“, „<i>ENDA</i>“, and „<i>OFFSA</i>“. So you can check if a frequency signal was connected to the input.
5.	The device shows „ <i>HELP</i> “ in the 7-segment display	<ul style="list-style-type: none"> The device located an error in the configuration memory, execute a reset to the default values and set up the device according to your application.
6.	Program numbers for the parameterisation of the input are not available	<ul style="list-style-type: none"> The programming intlock is activated. Enter correct code.
7.	The device shows „ <i>ERR1</i> “ in the 7-segment display	<ul style="list-style-type: none"> Contact the manufacturer if errors of this kind occur.
8.	The device does not react as expected.	<ul style="list-style-type: none"> If you are not sure, that the device has been parameterised before, restore the state of delivery as described in <i>chapter 6</i>.

