

## ● Characteristics

1 - MODULAR - ECONOMIC - SERIES -

	- Input:	pressure 0...0,1 up to 0...1000 bar
	- Output:	4...20 mA current loop HART (2-wire)
	- Voltage supply:	out of current loop (12...40 VDC)
	- Accuracy:	see technical details
	- Process connection:	several options
	- Electrical connection:	several plugs / cable
	- Temperature range:	-40...+80 °C (operation)
	- Limit value contacts:	2 electronically (NPN, PNP)
	- Adjustment:	keys / software
	- Temperature medium:	-30...+100 °C
	- Protection:	at least IP65 / IP68

## ● Technical data

### Input

Pressure: relative: 0...0,1 up to 0...1000 bar / -1...0 bar      absolute: 0...0,25 up to 0...16 bar  
 Pressure ranges: see table page 2 (with overpressure safety, burst pressure)

### Output

Current signal: 4...20 mA with superimposed communication signal (HART), 2-wire current loop  
 Current range: 3,8...20,8 mA  
 Signal on error: 3,8 mA (sensor break, sensor open circuit)

### Performance

Sensor:	Accuracy:	<0,5% of span
	Including non-linearity, hysteresis, zero and full scale error (corresponds to error of measurement per IEC 61298-2)	
	Adjustment:	in vertical mounting position with lower pressure connection
	Non-linearity:	<0,2% of span (BFSL per IEC 61298-2)
	Non-repeatability:	<0,1% of span (per IEC 61298-2)
Measuring amplifier:	1-year stability:	<0,2% of span (at reference conditions)
	Resolution:	16 Bit / 0,3 µA
	Long term stability:	0,05% / year
	Filter setting:	yes
	Transmission behaviour:	linear with pressure
Indicator / limit values:	Turn-on delay time:	<5 s
	Response time:	1 s
	Resolution:	-9999...9999 digit
	Error of measurement:	±0,2% of range, ±1 digit
	Temperature drift:	100 ppm/K
Features:	according VDMA 24574-1 up to 24574-4	
	Operation: according VDMA 24574-1 up to 24574-4	

## ● Applications

For use in industrial plants, terotechnology and public utility (eg tanks for drinking water). With it's two configurable limit value contacts, the integrated display and the numerous electrical connections, the pressure sensor is also suitable for applications with higher requirements.



## ● Technical data (continued)

### Indication

Display: 7 segment, 8,5 mm, red, 4 digits, representation mirror-inverted 180° possible  
 Head of display: rotatable approx. 330°  
 Memory: minimum / maximum values  
 Indication: - measuring value - unit of measurement - control menu  
 Decimal point: automatically or manually, dependent on measuring range / unit  
 Representation: xxxx / xxx.x / xx.xx / x.xxx

### Limit contacts

Electronically: 2x NPN or PNP (30 VDC, 200 mA) Option: 2x NPN or PNP (30 VDC, 1000 mA)  
 Indication: 1 LED red for each limit value  
 Voltage across: <1 V  
 Settings: with 3 keys (TouchM-Technology)  
 Setting range: switch point and hysteresis: any value within measuring range  
 Switching delay: 0,0...999,9 s  
 Failsafe function: adjustable  
 Galvanical insulation: switching outputs are separated from measuring amplifier

### Supply

Voltage: HART current loop: 12...40 VDC VDC  
 Load:  $R = (U_B - 12 \text{ V}) / 22 \text{ mA}$   
 Reverse battery protection: available (no function, no damage)

### Ambient conditions

Temperature: Operating range: 0...+80 °C (nominal range)  
 Storing: -20...+85 °C  
 Medium: -30...+100 °C  
 Temperature coefficient: mean temperature coefficient (TC) within rated temperature range  
 TC zero: <0,2% of span / 10 K  
 TC span: <0,4% span / 10 K for ranges <250 mbar  
 <0,2% span / 10 K  
 Condensation: uncritical  
 CE-conformity: Pressure equipment directive: 97/23/EG EMC directive: 2004/108/EG  
 Shock resistance: 1000 g according IEC 60068-2-27 (mechanical shock)  
 Vibration resistance: 20 g according IEC 60068-2-6 (vibration under resonance)

### Mechanics

Dimensions: see page 3  
 Pressure connection: G 1/2 (EN837) / G 1/4 (EN837) / G 1/4 (DIN 3852-E) / 1/2 NPT / 1/4 NPT  
 for NPT thread: nominal size for "US standard tapered pipe thread NPT"  
 Electrical connection: see page 3  
 Material: Process connection: stainless steel CrNi (contact with medium)  
 Body: PBT GF30  
 Head of display: polycarbonate  
 Transmission fluid: syntetic oil (internal), no transmission fluids for models with pressure ranges >25 bar  
 Weight: approx. 240 g  
 Protection of device: Ingress protection: at least IP 65 (electronics)  
 PCB: potted









### Programmable features

Measuring amplifier: measuring range start / measuring range end /  
 Display: range of indication / time of indication / decimal point / units / stabilisation of zero point /  
 locking of programming / calibration points / TAG number  
 Limit value contacts: limit value 1 and 2 / hysteresis 1 and 2 / delay times 1 and 2

### Pressure table

Pressure range	0,1	0,16	0,25	0,4	0,6	1	1,6	2,5
Overpressure safety	1	1,5	2	2	4	5	10	10
Burst pressure	2	2	2,4	2,4	4,8	6	12	12
Pressure range	4	6	10	16	25	40	60	100
Overpressure safety	17	35	35	80	50	80	120	200
Burst pressure	20,5	42	42	96	96	400	550	800
Pressure range	160	250	400	600	1000			
Overpressure safety	320	500	800	1200	1500			
Burst pressure	1000	1200	1700	2400	3000			

**● Electrical connection**

M12x1	Super Seal	Deutsch	Deutsch	Bayonet	Valve	MIL	Cable
							
4-, 5-, 8-pole	3-pole	3-pole	4-pole	4-pole	4-pole	6-pole	4-, 6-pole

Connection	M12 4-pole	M12 5-pole	M12 8-pole	Bayonet 4-pole	Deutsch 4-pole	Deutsch 3-pole	Super Seal 3-pole	Valve 4-pole	MIL 6-pole	Cable <sup>1)</sup> 4-pole 6-pole
Limit value (LV)										
1 electronical LV	X	X	X	X	X			X	X	X
2 electronical LV		X	X						X	X

1) 4-pole (+shield) without and 1 limit value contact, 6-pole (+shield) with 2 limit value contacts

**● HART Communication and configuration**

The HART-Tool is a graphical user interface for the ME series with menu-driven program for configuration. It can be used for putting into operation, configuration, analysis of signals, data backup and documentation of the device. Connection via HART interface DEV-HM for operating systems: Windows 2000, Windows XP. Possible settings are: Adjustment and simulation of output current, filter function, limits of measuring range, linear output signal, HART address, HART TAG number, 2-point calibration, 6-point calibration (linearization)

**Please note:** When using communication via a HART modem, a communication resistance of 250 Ω has to be taken into account.

**● Dimensions (in mm)**

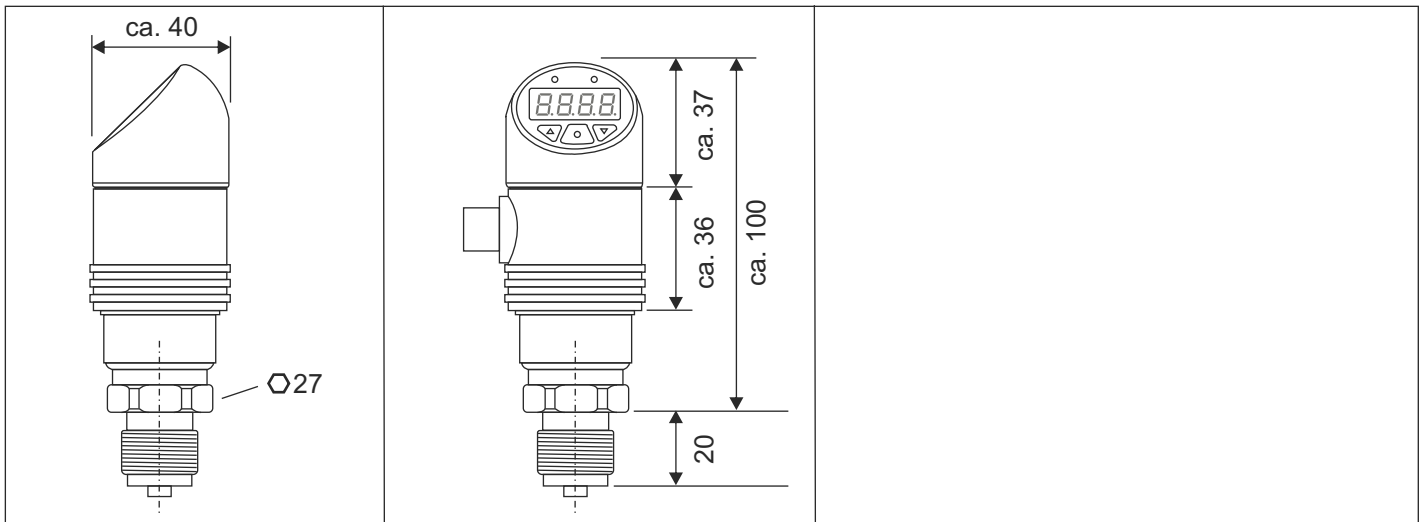

**● Pressure connection (in mm)**

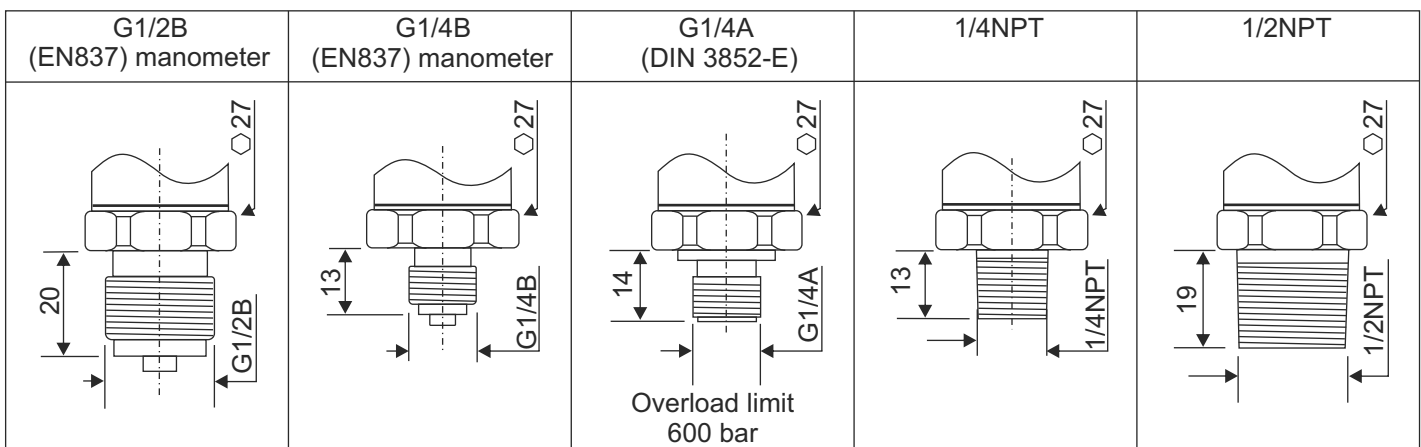

● **Ordering code**

O P X X X X X X - X X X

<b>Kind of pressure:</b>	Relative pressure	0																		
	Absolute pressure	1																		
<b>Temperature medium:</b>	-30...+100 °C		0																	
<b>Process connection:</b>	G1/2" (EN 837), manometer		0																	
	G1/4" (EN 837), manometer		1																	
	G1/4" (DIN 3852 E)		2																	
	1/2"NPT		3																	
	1/4"NPT		4																	
	Other connection (to indicate)		5																	
<b>Contact with medium:</b>	CrNi steel		0																	
<b>Pressure range:</b>	To indicate <sup>1)</sup>									X										
<b>Limit value contacts:</b>	2x PNP, 30 VDC, 200 mA (standard)																			0
	1x PNP, 30 VDC, 200 mA																			1
	Without																			2
	2x NPN, 30 VDC, 200 mA																			3
	1x NPN, 30 VDC, 200 mA																			4
	2x PNP, 30 VDC, 1000 mA																			5
	1x PNP, 30 VDC, 1000 mA																			6
	2x NPN, 30 VDC, 1000 mA																			7
	1x NPN, 30 VDC, 1000 mA																			8
<b>Electrical connection:</b>	M12, 4-pole																			0
	M12, 5-pole																			1
	M12, 8-pole																			2
	Deutsch DT04, 3-pole																			3
	Deutsch DT04, 4-pole																			4
	Super Seal 1.5, 3-pole																			5
	Bayonet (DIN), 4-pole																			6
	Valve plug, 4-pole																			7
	Cable, 2 m																			8
	MIL, 6-pole																			9
<b>Configuration:</b>	Factory setting <sup>2)</sup>																			0
	Customized (please indicate) <sup>3)</sup>																			1
<b>Other:</b>	Special model																			0

1) Pressure range absolute: 2 = 0...0,25 / 3 = 0...0,4 / 4 = 0...0,6 / 5 = 0...1 / 6 = 0...1,6 / 7 = 0...2,5 / 8 = 0...4 / 9 = 0...6 / A = 0...10 / B = 0...16 bar  
 Pressure range relative: 0 = 0...0,1 / 1 = 0...0,16 / 2 = 0...0,25 / 3 = 0...0,4 / 4 = 0...0,6 / 5 = 0...1 / 6 = 0...1,6 / 7 = 0...2,5 / 8 = 0...4 / 9 = 0...6 / A = 0...10 / B = 0...16 / C = 0...25 / D = 0...40 / E = 0...60 / F = 0...100 bar / G = 0...160 / H = 0...250 / I = 0...400 / J = 0...600 / K = 0...1000 / L = -1...0 bar

2) Measuring range: / Indicating range

3) All settings, which are possible according the technical data, can be selected. For not given values the details of factory-set are used.

**Accessories:**  
 DEV-HM (Interface HART, USB, software) Order No.: