MG-XV operating instruction

Measuring of norm signals, 4-8-digit



Panel instrument – type MG-BV

Construction instrument – type MG-AV

Contents

1.	Brief description	3
2.	Safety instructions	3
2.1.	Proper use	3
2.2.	Control of the device.....	3
2.3.	Installation	3
2.4.	Notes on installation	3
3.	Assembly	4
3.1.	Panel instrument – type MG-BV (57 mm and 100 mm digit height).....	4
3.2.	Construction instrument MG-AV (57 mm and 100 mm display height).....	5
4.	Electrical connection.....	6
4.1.	Terminal pin assignment for built-on devices	6
	Position of terminal plugs (MG-AV).	7
4.2.	Terminal pin assignment for panel devices	7
4.3.	Connecting examples for MG-AV	8
5.	Operation /display elements	9
5.1.	Operation and display elements	9
5.2.	Switching on	10
5.3.	Starting sequence.....	10
5.4.	MIN/MAX-memory	10
5.5.	Overflow and underflow.....	10
5.6.	Limit value monitoring.....	10
5.6.1.	Optical response, flashing display	11
6.	Programming	12
6.1.	Programming procedure	12
6.1.1.	Change to operating mode	13
6.2.	Measuring input	13
6.2.1.	Factory calibration	14
6.2.2.	Sensor calibration.....	14
6.2.3.	Sensor linearisation	14
7.	Device parameter	15
7.1.1.	Measuring input PN 0	15
7.1.2.	Scaling PN1 and PN2	15
7.1.3.	Decimal point PN3	15
7.1.4.	Rounding PN4	15
7.1.5.	Offset shift PN5.....	16
7.1.6.	Zero point suppression PN10	16
7.1.7.	Indication time PN13.....	16
7.1.8.	Measuring time PN14	16
7.1.9.	Security setting, user level PN50 to PN52	16
7.1.10.	Display flashing PN59	17
7.1.11.	Switching points PN60 to PN75.....	17
7.1.12.	Linearisation PN100 to PN110	17
7.1.13.	Serial number PN200	17
8.	Program table	18
9.	Technical data	20
10.	Troubleshooting	23
10.1.	Questions and answers	23
10.2.	Reset to default values	23

Brief description

1. Brief description

With the **MG-XV** device standard signals 0/4...20 mA DC or 0...5/10 VDC can be measured. The 4-digit display shows the measurements or the scaled value of the measurement. During programming the display is used to indicate the set values and the user prompt. The integrated 24 VDC sensor supply is used to supply possible sensors.

2. Safety instructions

Please read the users guide before installation and keep it for future reference.

2.1. Proper use

The **MG-XV** is designed for the evaluation and display of sensor signals.



Danger! Careless use or improper operation can result in personal injury and/or damage to the equipment.

2.2. Control of the device

The devices are checked before dispatch and sent out in perfect condition. Should there be any visible damage, we recommend close examination of the packaging. Please inform the supplier immediately of any damage.

2.3. Installation

The **MG-XV** must be installed by a suitably qualified specialist (e.g. with a qualification in industrial electronics).

2.4. Notes on installation

- There must be no magnetic or electric fields in the vicinity of the device, e.g. due to transformers, mobile phones or electrostatic discharge.
- The fuse rating of the supply voltage should not exceed a value of 6A N.B. fuse.
- Do not install inductive consumers (relays, solenoid valves etc.) near the device and suppress any interference with the aid of RC spark extinguishing combinations or free-wheeling diodes.
- Keep input, output and supply lines separate from one another and do not lay them parallel with each other. Position go and return lines next to one another. Where possible use twisted pair.
- The device is not suitable for installation in areas where there is a risk of explosion (hazardous areas).**
- Any electrical connection deviating from the connection diagram can endanger human life and/or can destroy the equipment.
- The device must not be mounted in the field of direct solar radiation.
- Do not install several devices immediately above one another (ambient temperature; see *technical data*).

Assembly

3. Assembly

On front of the **MG-XV** are the operating and display elements. The **MG-XV** is intended for installation in a control panel or as constructive instrument (please indicate which version when ordering).

3.1. Panel instrument – type **MG-BV** (57 mm and 100 mm digit height)

Before assembly, a cut-out must be made to accommodate the device. The sizes and tolerances are given in the technical data. The device should be installed with the supplied fixtures in line with the drawings.

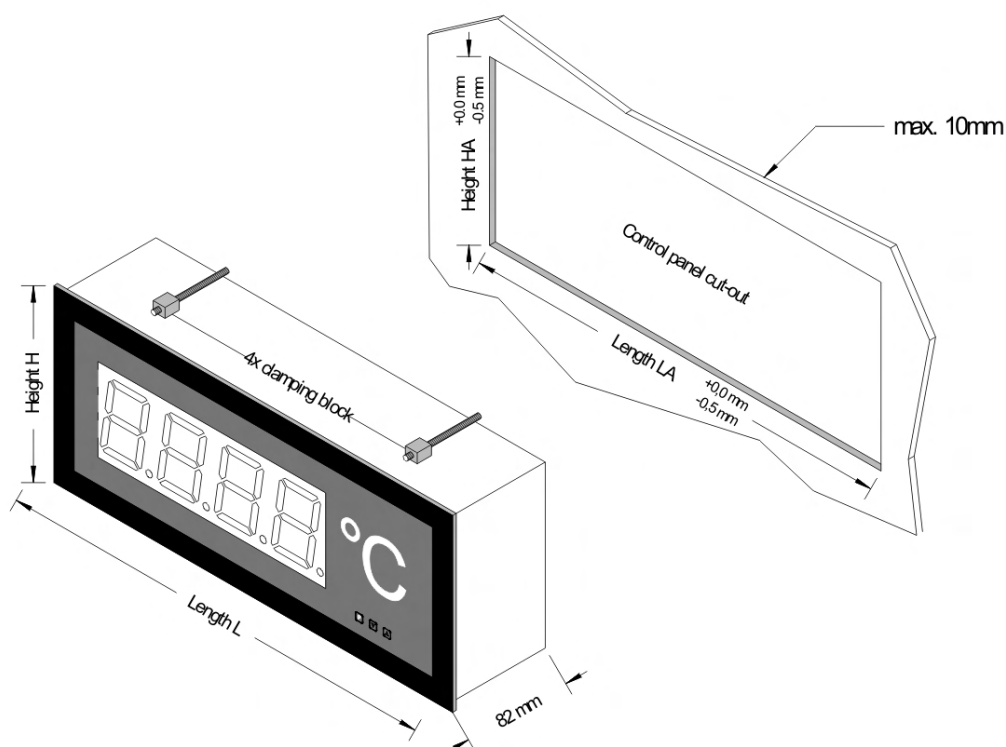

Display 57 mm

Version A

Number of digits	Length L	Length LA	Height H	Height HA
3-digit with physc. value	288mm	282mm	144mm	138mm
4-digit with physc. value	336mm	330mm		
5-digit with physc. value	384mm	378mm		
6-digit with physc. value	432mm	426mm		
7-digit with physc. value	480mm	474mm		

Version B

Number of digits	Length L	Length LA	Height H	Height HA
3-digit with physc. value	268mm	262mm	124mm	118mm
4-digit with physc. value	316mm	310mm		
5-digit with physc. value	364mm	358mm		
6-digit with physc. value	412mm	406mm		
7-digit with physc. value	460mm	454mm		

Display 100 mm

Version A

Number of digits	Length L	Length LA	Height H	Height HA
3-digit with physc. value	460mm	454mm	200mm	194mm
4-digit with physc. value	550mm	544mm		
5-digit with physc. value	640mm	634mm		
6-digit with physc. value	730mm	724mm		
7-digit with physc. value	820mm	814mm		

Version B

Number of digits	Länge L	Länge LA	Höhe H	Höhe HA
3-digit with physc. value	436mm	430mm	176mm	170mm
4-digit with physc. value	526mm	520mm		
5-digit with physc. value	616mm	610mm		
6-digit with physc. value	706mm	700mm		
7-digit with physc. value	796mm	790mm		

Assembly

3.2. Construction instrument **MG-AV** (57 mm and 100 mm display height)

For fixing of the device, please use the assembly drillings in the fastening angle.

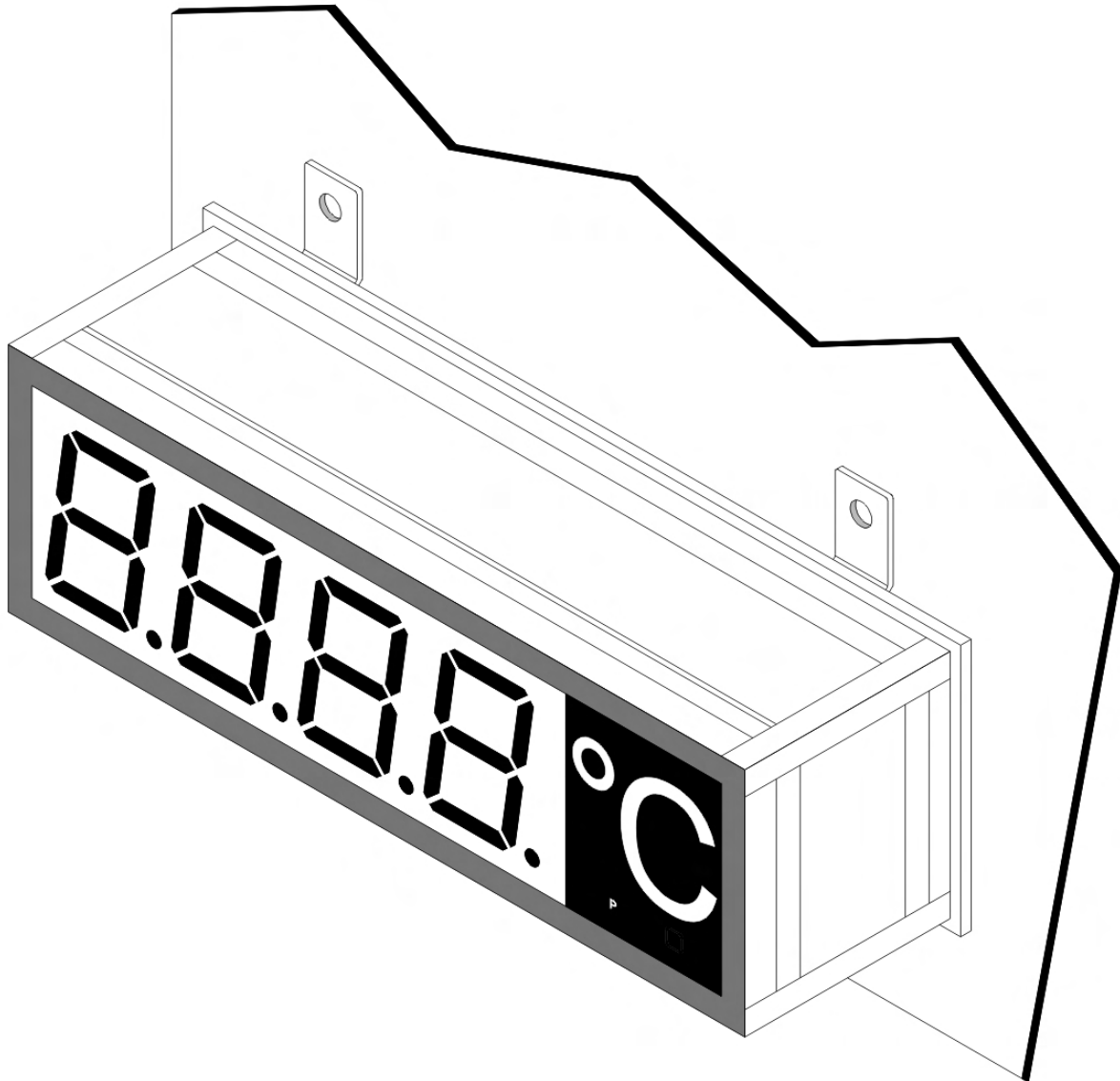

Electrical connection

4. Electrical connection

All signals that are needed for operation can be connected on the rear or the top side of the device. All possible connection details of the **MG-XV** are given below.

4.1. Terminal pin assignment for built-on devices

Built-on device **MG-AV**

Stecker A:
Netzanschluss 230 VAC

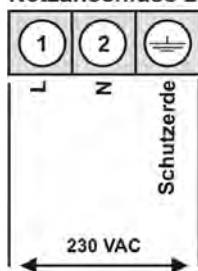

Stecker A:
Netzanschluss + 24 VDC

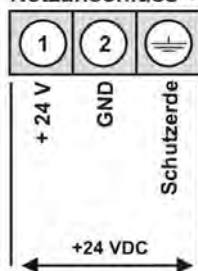

Stecker B: Messeingang und Geberversorgung

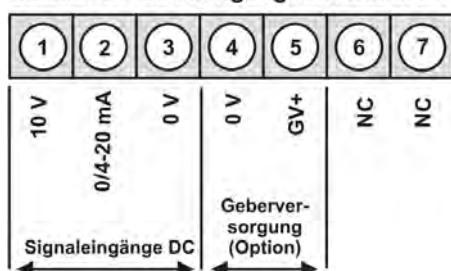

Stecker C: Relais

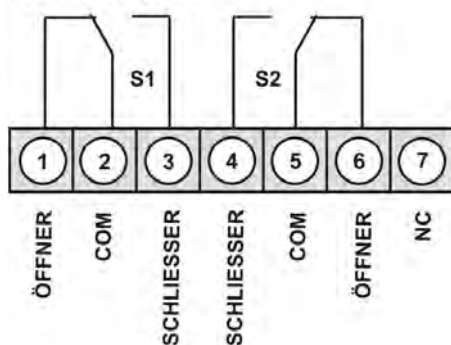

Electrical connection

Position of terminal plugs (MG-AV)

Advice: For devices with serial numbers < 1130XXXX the position of the terminal plugs vary.

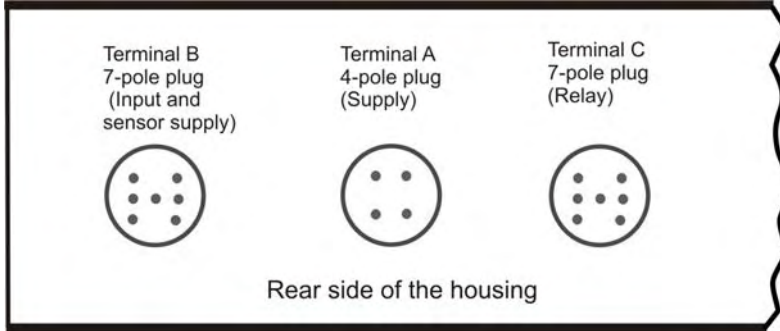

4.2. Terminal pin assignment for panel devices

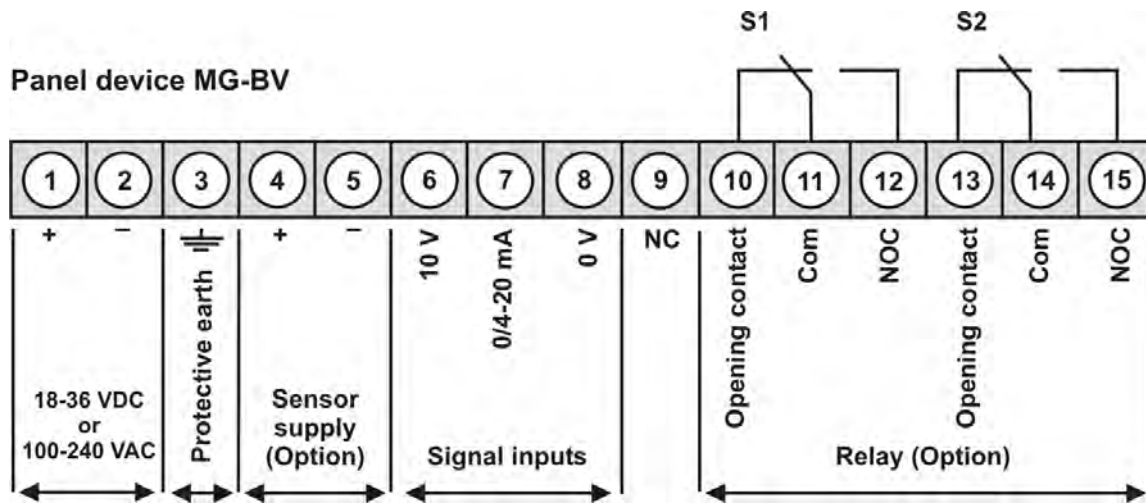

Electrical connection

4.3. Connecting examples for MG-AV

This section gives a few examples of practical connections. Other connection options can be combined from the various examples.

Measuring a current signal from a 2-wire transmitter, using the sensor supply:

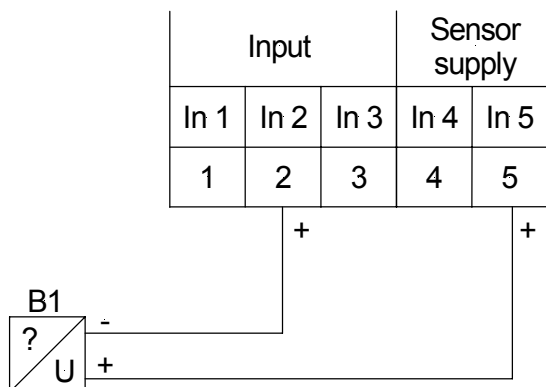

Measurement of a voltage signal (0...5 V or 0...10 V) from a 3-wire transmitter using the sensor supply 12-24 VDC.

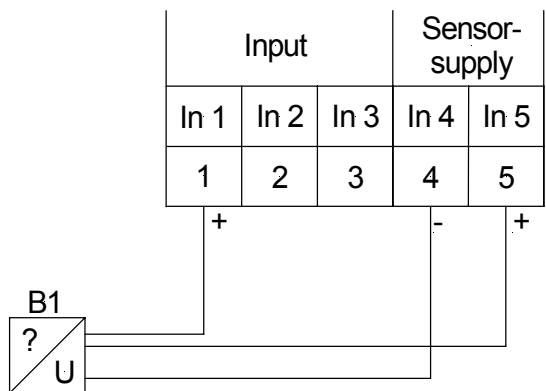

Measuring a current signal (0...20 mA) from a 3-wire transmitter using the transmitter supply 12 or 24 VDC.

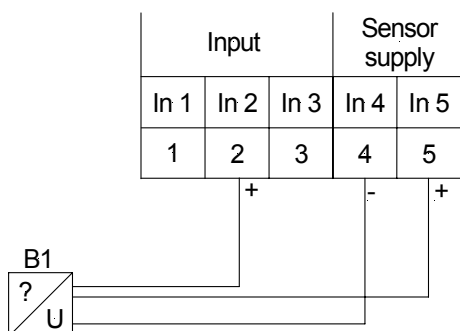

Operation

5. Operation /display elements

This unit is operated via the [P], [▲] and [▼] keys and has a 4-digit 7-segment display.

5.1. Operation and display elements

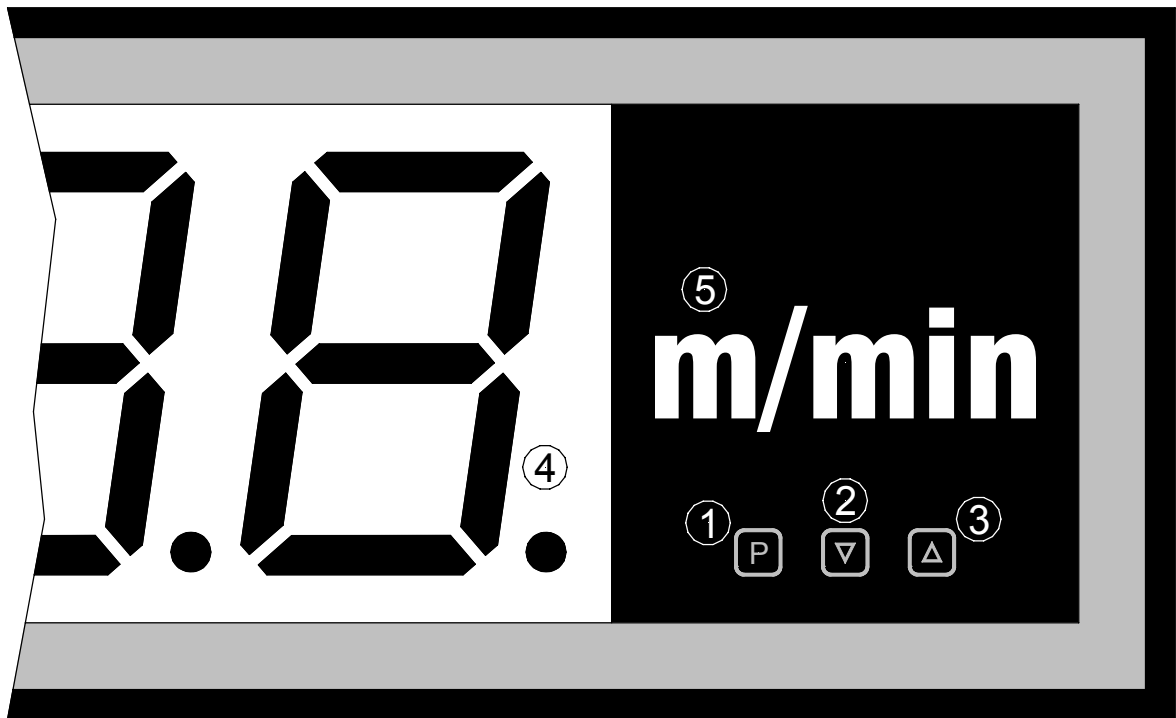

- | | | |
|---|--------------------|---|
| 1 | Program key
[P] | With the program key, you can call up the programming mode or perform various functions in the programming mode. |
| 2 | MINUS key
[▼] | With the decrease key, you can call up the MIN memory or alter parameters in the programming mode. |
| 3 | PLUS key
[▲] | With the increase key, you can call up the MAX memory or alter parameters in the programming mode. |
| 4 | 7-segment display | The 7-segment display shows measurements or, during programming, the program numbers or parameters. |
| 5 | Dimension window | The dimension window shows the factory-set physical unit for the measurement. Here, a physical unit can be placed according to customer preferences. |

Operation

5.2. Switching on

Before switching on you have to check all the electrical connections to make sure they are correct. On completion of the installation, the device can be switched on by applying the power supply.

5.3. Starting sequence

During the switching-on process a segment test is performed for approx. 1 second, whereby all LED on the front (including alarm LED) are triggered. After this, the type of software is indicated for approx. 1 second and then, also for 1 second, the software version. After the starting procedure, the unit changes to operation/display mode.

5.4. MIN/MAX-memory

The measured minimum and maximum values are saved in a volatile memory in the unit and get lost when the unit is switched off.

You can call up the contents of the memory by pushing (less than 1 second) the [▲] or [▼] key. The relevant value is indicated for approx. 7 seconds. By briefly pressing the same key again, you will return immediately to the display mode.

[▲] ⇒ Display of the MAX value

[▼] ⇒ Display of the MIN value

You can erase the value shown in the display by simultaneously operating the [▲] & [▼] keys. The erasure is acknowledged by horizontal bars.

The content of the memory is lost when the unit is switched off.

5.5. Overflow and underflow

An overflow of the display is indicated by horizontal bars at the top of the 7-segment display „ “.

An underflow of the display is indicated by horizontal bars at the bottom of the 7-segment display „ “.

5.6. Limit value monitoring

The limit value monitoring has the following properties:

Limit value alarm x	deactivated, activated
Limit value	threshold of limit value monitoring
Hysteresis	Width of the window between the switch thresholds
Operating principle	active above SP value / active below SP value
Switch-on delay	Time between reaching the limit value alarm and the resultant switching on of the limit value alarm.
Switch-off delay	Time between reaching the limit value alarm and the resultant switching off of the limit value alarm.

Operation

Exceedance

The limit value alarm is off below the limit value and switched on on reaching the limit value.

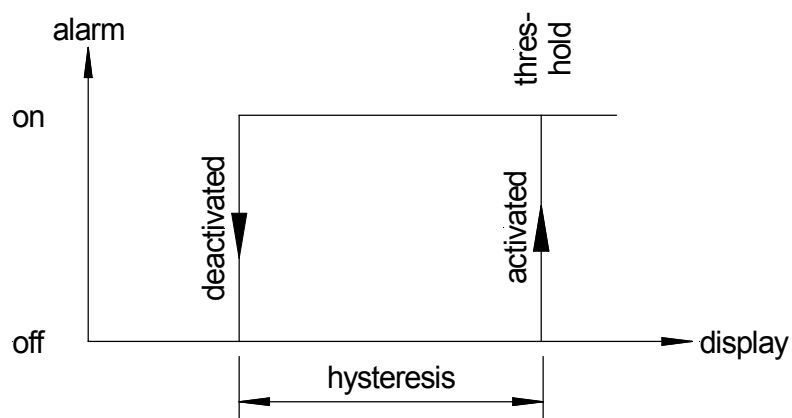

Undershooting

The limit value alarm is on below the limit value and switched off on reaching the limit value.

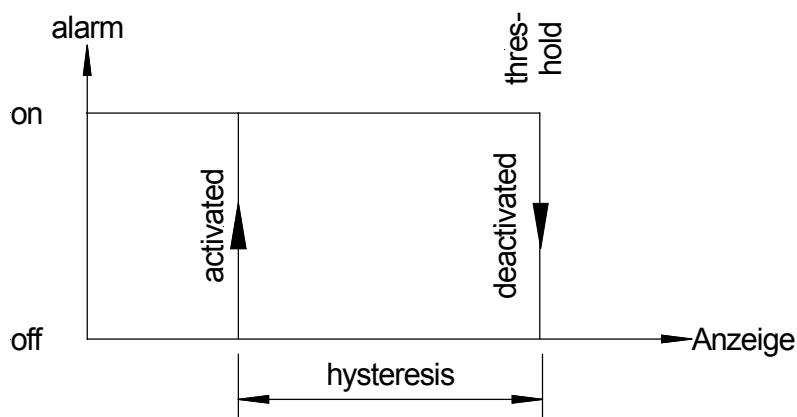

Alarm delay

The alarm is on e.g. 10 seconds after reaching the limit value; briefly exceeding the limit value does not lead to the alarm being switched on. The switch-off delay works in a similar manner, in other words, it keeps the alarm output switched on until the parameterised time has elapsed.

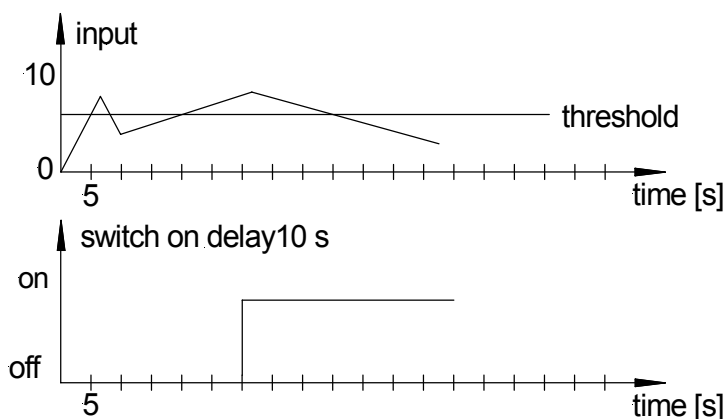

5.6.1. Optical response, flashing display

The switching on of one or more alarm outputs can also be set to trigger a flashing of the display to enhance the optical response.

Programming

6. Programming

The display shows the program numbers (PN) right-aligned, as a 3-digit number with a **P** at the front.

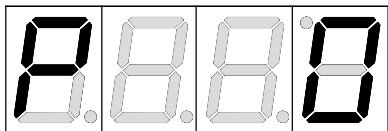

Display of e.g. program number 0

6.1. Programming procedure

The entire programming of the **MG-XV** is done by the steps described below.

Change to the programming mode

Push the [**P**] key to change to programming mode. The unit goes to the lowest available program number. When the programming lock is activated, the key must be pressed for at least 1 second.

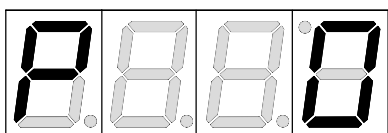

Example:

Change to programming mode by pushing key [**P**]. The first released program number (PN) appears, in this case PN0.



Change between program numbers

To change between individual program numbers, hold the [**P**] key down and press the [**▲**] key for changing to a higher program number or the [**▼**] key for changing to a lower number. By keeping the keys pushed, e.g. [**P**] & [**▲**], the display will begin, after approx. 1 second, to automatically run through the program numbers.

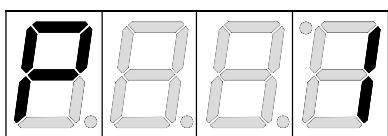

Example:

A 1 is parameterised under PN0.
Hold the [**P**] key down and press the [**▲**] key once.
PN1 appears in the display. Under this parameter, the final value of input can be changed.



Change to the parameter

Once the program number appears in the display, you can press the [**▼**] or [**▲**] key to get to the parameters set for this program number. The currently stored parameter is displayed.



Example:

By pressing the [**▼**] or [**▲**] key, the currently stored value for PN1 appears in the display.
In this case, it is **75.64**.



Programming

Changing a parameter

After changing to the parameter, the lowest digit of the respective parameter flashes on the display. The value can be changed with the [▲] or [▼] key. To move to the next digit, the [P] key must be briefly pressed. Once the highest digit has been set and confirmed with [P], the lowest digit will begin to flash again.



Example:

The 4 is flashing; this is the lowest value digit and, by flashing, it is asking for a figure to be entered. In our example, the value is to be changed from **75.64** to **75.00**. You can change the value by changing the figure from 4 to 0 using the [▲] or [▼] key. To move to the next digit,

the [P] key must be briefly pressed. The 6 begins to flash. Change the value from 6 to 0 using the [▲] or [DOWN] key. The 5 and the 7 need no change.

Saving parameters

All parameters must be acknowledged by the user by pressing the [P] key for one second. The changed parameters are then taken over as the current operating parameters and saved in the EEPROM. This is confirmed by horizontal bars lighting up in the display.

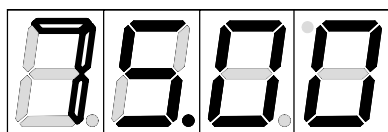

Example:

Save the parameters by pressing [P] for 1 second.

All the newly entered data are confirmed by the unit. If no confirmation is received, the relevant parameters have not been saved.

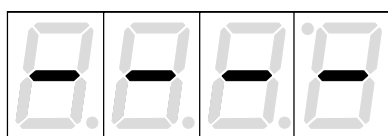

Example:

You receive a confirmation from the unit that the changes have been saved through the appearance of horizontal bars in the middle segments.

6.1.1. Change to operating mode

If no key is pressed in programming mode for approx. 7 seconds, the unit automatically returns to operating mode.

6.2. Measuring input

The **MG-XV** is equipped with a measuring input for standard signals that enables standardised signals (e.g. 4...20 mA) from all kinds of different measuring transmitters on the market to be measured directly.

Programming

6.2.1. Factory calibration

For this, various sensor values for 0...10 V, 0...5 V, 0...20 mA and 4...20 mA are stored in the unit and can be called up via the parameter PN0. They are called *factory calibrations* because the data were established during production and are saved permanently in the unit. It means that a pre-adjusted transmitter can be operated directly with the indicator without any need to previously connect the signal to be measured to the indicator.

The indicator can be scaled freely according to the physical dimension to be measured.

6.2.2. Sensor calibration

If, on the other hand, the sensor has not been pre-calibrated, the indicator can be adjusted and calibrated direct via the measurement together with the sensor path. This can be selected via the parameter PN0=0 and is consequently called *sensor calibration*.

6.2.3. Sensor linearisation

In addition, non-linear sensors can be linearised with the aid of a characteristic line that can be saved in the indicator. This is described with the following example: The sensor signal must be **parameterised in a strictly monotonously manner**, i.e. every new calibration point (e.g. PN104) must have a higher input signal than the previous one (e.g. PN103) so that it is taken over by the indicator. Otherwise, no confirmation will be shown. On the other hand, the relevant indication values do not need to increase constantly. They can also fall or alternate between rising and falling.

Example:

To program e.g. 5 additional calibration points, 5 must be entered under PN100.

Subsequently, for each of the calibration points, the voltage/current must be applied to the unit and the respective indication value programmed under the following program numbers PN101–PN105.

Linearisation of a pressure transmitter (0...100 mbar) with a 0...20 mA output.

The indicated value before correction can be either calculated from the known characteristic line of the transmitter or determined empirically.

Programming

The non-linear range between 0...75 mbar. For calibration point 101, this means:
A pressure of 15 mbar, the transmitter delivers 3.3 mbar instead of the ideal value of 3.0 mbar. Since 20 mA in the display corresponds to 100.0 mbar, 3.3 mA in the display corresponds to 16.5 mA before the correction.

Calibration point (PN)	Pressure [mbar]	Output transmitter [mA]	Indication before correction (IN)	Desired indication (OUT)
2	0	0.5	2.5	0.0
101	15	3.3	16.5	15.0
102	30	6.2	31.0	30.0
103	40	9.2	46.0	40.0
104	60	11.4	57.0	60.0
105	75	14.7	73.5	75.0
1	100	20.0	100.0	100.0

7. Device parameter

The **MG-XV** has a number of unit parameters with which the function of the indicator can be adjusted to the relevant measuring tasks. Because of the large number of these settings and the limited possibility of displaying them on the 7-segment display, the parameters have been given consecutive numbers.

7.1.1. Measuring input PN 0

One of the aspects in the basic configuration is the desired measuring input, which consists of the terminal selection and the relevant factory or sensor calibration.

7.1.2. Scaling PN1 and PN2

The two program numbers 1 and 2 are used to scale the indication. With these two parameters, the end value and start value are parameterised. If sensor calibration has been selected via PN0=0, then the current for the relevant sensor signal must be applied during programming. Otherwise, a simple allocation of the selected input configuration will be made. For example, at PN0=3, which corresponds to a standard signal input 0 ... 10 V, the value saved under PN1 will be indicated at 10 V, and the value saved under PN2 will be indicated at 0 V.

7.1.3. Decimal point PN3

By changing this parameter, the number of places shown after the decimal point in the display is changed. This parameter has no influence on the scaling of the indication value, only on the position of the decimal point in the display.

7.1.4. Rounding PN4

The rounding function is used for tranquilization of very disturbed signals for the viewer. The resolution of the display is limited by simple rounding on 5, 10, 50, 100, 500, 1000. If PN4=5, then we come to the following display sequence while rising input signal: 0, 5, 10, 15, 20, 25, 30, 35, 40...

If PN5=10 is selected, there is always a "0" displayed on the last digit. This can be very reasonable for physical values like e.g. mbar, so that the depiction of the display is coherent.

Programming

7.1.5. Offset shift PN5

With this parameter, it is possible to carry out a parallel shift of the parameterised characteristic line. This may be necessary if, for example, a pressure transmitter ages over the course of time, giving rise to a shift in the zero point. With the parallel shift, the transmitter can be adjusted back to the zero point. Another application is to parameterise a certain tank level to zero and have any deviation from this level displayed.

7.1.6. Zero point suppression PN10

Via the zero point suppression, an indication value window can be defined as zero. This means, for example, that at PN10=10, all indication values between -10...10 are shown in the display as zero. This function is intended to produce a reliable zero indication at high display resolution and low sensor accuracy around zero. This could be, for example, the rpm of an engine for which a zero would be expected in the display when standing still.

7.1.7. Indication time PN13

The indication time is the interval at which the display is updated. The longer the time between two indication cycles, the calmer the display. As a rule, the eye perceives the indication time of 1 second as very pleasant. If the adjusted indication time is longer than the adjusted measuring time (PN14), no averaging of the detected measuring values during the indication time takes place. The display will be always refreshed with the newest detected measuring value.

7.1.8. Measuring time PN14

The measuring time corresponds to the conversion time of the A/D conversion, which determines the response time of the alarm outputs. The longer the conversion time, the smaller the influence of disturbances and the higher the resolution of the measured signal.

7.1.9. Security setting, user level PN50 to PN52

With the parameters in the security settings, access to the program numbers is regulated through the setting of various user levels. The user levels divide the access into various levels. The user is only given access to the settings authorised by the system operator, such as the setting of thresholds. The lower the figure for the user level given under PN52, the lower the level of security of the unit parameters against user intervention.

User level (PN52 =)		0	1	2	3	4	5	6	7	8
Access to:	PN:									
Locking code / user level	51, 52	X								
Measuring input parameters	0 ... 18	X	X	X						
Linearisation parameters for the measuring input	100 ... 110	X	X	X						
Setting parameters of the alarm outputs	59, 60, 63 ... 65, 70, 73 ... 75	X	X	X	X	X				
Hysteresis of the alarm outputs	62, 72	X	X	X	X	X	X			
Threshold of the alarm outputs	61, 71	X	X	X	X	X	X	X		
Access code	50	X	X	X	X	X	X	X	X	X
Serial number	200	X	X	X	X	X	X	X	X	X

Programming

The user levels 1, 3 and 7 are reserved user levels, at which access to the higher numbered user level is active.

The parameterised user level PN52 is active as long as the locking code PN51 and the access code PN50 are different. On delivery both parameters are set to 0000, so that the programming lock is deactivated. To activate the set user level, you must enter a 4-digit number under PN51 as a “locking code” and confirm it by pressing the [P] key for approx. 1 second.

On changing to programming mode, the unit jumps to the first authorised program number. If user level PN52 = 3, then, for example, the parameters of the alarm outputs can be changed, but changing the parameter of the measuring input (PN0) is not possible at this user level.

In order to obtain access to all program numbers later (equivalent to user level 0), you have to enter under PN50 the same code you entered before under PN51. You must then acknowledge this by pressing the [P] key for approx. 1 second. After this you have access to all program numbers.

Caution! If the locking code becomes lost, the unit can be set to the default value 0000 at the manufacturer's without any data loss.

7.1.10. Display flashing PN59

By activating the display flashing, various alarm states can be optically reinforced. The trigger for the display flashing can be freely assigned to the alarm outputs.

7.1.11. Switching points PN60 to PN75

The behaviour of the switching points can be influenced via various program numbers. The data refer to the scaled measurement and are updated with the set measuring time.

A description of the various parameters is given in section **5.6. Limit value monitoring**.

7.1.12. Linearisation PN100 to PN110

Through linearisation, the user has the possibility to linearise a non-linear sensor signal. A detailed description can be found in the chapter on *sensor linearisation*. Under PN100, the desired number of additional set points can be released. Only after changing the number are they accessible via the configuration PN101 to max. PN110. If PN100=0, then no PN101 will be displayed. To monitor the desired linearisation, all the set points should first be parameterised, otherwise there may be deviations from the desired value in the display!

7.1.13. Serial number PN200

Under PN200 the 4-digit serial number can be called up that allows allocation to the production process and the manufacturing procedure. This parameter can only be viewed.

Program table

8. Program table

The program table lists all the program numbers (PN) with their function, range of values, default values and user level.

PN	Function	Range of values	Def- ault	User level
Channel 1				
0	Measuring input Parameters 1 to 4 make use of the factory calibration.	Current, voltage 0 = Sensor calibration 1 = 0...20 mA 2 = 4...20 mA 3 = 0...10 V 4 = 0...5 V	2	2
1	Final value / full scale	-999...9999	1000	2
2	Zero point / offset	-999...9999	0	2
3	Number of decimal places	0 = 0 1 = 0.0 2 = 0.00 3 = 0.000	0	2
4	Rounding	0 = 1 1 = 5 2 = 10 3 = 50 4 = 100 5 = 500 6 = 1000	0	2
5	Offset shift to display value	-999...9999	0	2
10	Zero point suppression	0...999	0	2
General settings				
13	Indication time	0.1 ... 10.0	1.0	2
14	Measuring time	0.1 ... 10.0	1.0	2
Security settings				
50	Programming lock	0000...9999	0000	8
51	Authorisation code	0000...9999	0000	0
52	User level	1...8	8	0
Flashing of the LED display				
59	Display flashing (approx. 0.5 seconds) No flashing Flashing at limit value alarm 1 Flashing at limit value alarm 2 Flashing at limit value alarm 1 and 2	0 no flashing 1 = flashes with 1 st 2 = flashes with 2 nd 3 = flashes with 1 st and 2 nd	0	4

Program table

PN	Function	Range of values	Def- ault	User level
Limit value alarm 1				
60	Limit value alarm 1	0 = deactivated 1 = activated	1	4
61	Limit value	-999...9999	1000	6
62	Hysteresis	1...9999	1	5
63	Monitoring principle limit value	0 = Exceedance 1 = Undershooting	1	4
64	Switch delay in seconds	0...1000 seconds	1	4
65	Delay type	0 none 1 switch-on delay 2 switch-off delay 3 switch-on/-off delay	0	4
Limit value alarm 2				
70	Limit value alarm 2	0 = deactivated 1 = activated	1	4
71	Limit value	-999...9999	1000	6
72	Hysteresis	1...9999	1	5
73	Monitoring principle limit value	0 = Exceedance 1 = Undershooting	1	4
74	Switch delay in seconds	0...1000 seconds	1	4
75	Delay type	0 none 1 switch-on delay 2 switch-off delay 3 switch-on/-off delay	0	4
Linearisation				
100	Number of additional calibration points	0...10	0	2
101	Calibration points 1...30	-999...9999		2
...				
130				
Information				
200	Serial number	0...9999	0	8

Technical data

9. Technical data

Housing dimension

Panel meter

(without plug)

Version A

57 mm display
100 mm display

W 336 x H 144 x D 82 mm
W 550 x H 200 x D 82 mm

Version B

57 mm display
100 mm display

W 316 x H 124 x D 82 mm
W 526 x H 176 x D 82 mm

(with plug)

Version A/B

57 mm / 100 mm display

W ... x H ... x **D 104 mm**

Assembly cut out

Version A

57 mm display
100 mm display

W 330.0^{-0.5} x H 138.0^{-0.5} mm
W 544.0^{-0.5} x H 194.0^{-0.5} mm

Assembly cut out

Version B

57 mm display
100 mm display

W 310.0^{-0.5} x H 118.0^{-0.5} mm
W 520.0^{-0.5} x H 170.0^{-0.5} mm

Weight

57 mm display
100 mm display

approx. 2.2 kg
approx. 4.2 kg

Connection

57/100 mm display

4-way adaptable screw terminal for voltage supply for line diameter by 2.5 mm²
9-way adaptable screw terminal for voltage supply for line diameter by 1.5 mm²

Display

Display
Digit height
Segment colour
Number of digits
Display range
Overflow
Underflow
Display time
Field of application

7-segment LED
57 mm, 100 mm, 200 mm
Red (optional green)
4 digits (optional 5-8 digits)
-999...9999 (-9999...99999)
horizontal bars at the top
horizontal bars at the bottom
0.1...10.0 seconds
Indoor

Technical data

Housing dimension

Panel meter

(without plug)

Version A

57 mm display
100 mm display

W 336 x H 144 x D 82 mm
W 550 x H 200 x D 82 mm

Version B

57 mm display
100 mm display

W 316 x H 124 x D 82 mm
W 526 x H 176 x D 82 mm

(with plug)

Version A/B

57 mm / 100 mm display

W ... x H ... x **D 104 mm**

Assembly cut out

Version A

57 mm display
100 mm display

W 330.0^{-0.5} x H 138.0^{-0.5} mm
W 544.0^{-0.5} x H 194.0^{-0.5} mm

Assembly cut out

Version B

57 mm display
100 mm display

W 310.0^{-0.5} x H 118.0^{-0.5} mm
W 520.0^{-0.5} x H 170.0^{-0.5} mm

Weight

57 mm display
100 mm display

approx. 3.0 kg
approx. 5.0 kg

Connection

57/100 mm display

4-way adaptable screw terminal for voltage supply for line diameter by 2.5 mm²
9-way adaptable screw terminal for voltage supply for line diameter by 1.5 mm²

Display

Display
Digit height
Segment colour
Number of digits
Display range
Overflow
Underflow
Display time
Field of application

7-segment LED
57 mm, 100 mm
Red (optional green)
4 digits (optional 5-8 digits)
-999...9999 (-9999...99999)
horizontal bars at the top
horizontal bars at the bottom
0.1...10.0 seconds
Indoor

Technical data

Measuring range /	0...10 V	150 k Ω	0.1	± 1
Input resistance /	0...5 V	150 k Ω	0.1	± 1
	0...20 mA	100 Ω	0.1	± 1
(at measuring time = 1 s)	4...20 mA	100 Ω	0.1	± 1
Temperature drift	all measuring inputs 50 ppm/K			
Measuring time & display time	0.1...10.0 seconds			
Measuring principle	Voltage-/frequency converter			
Resolution	approx. 20 bit			
(at measuring time = 1 s)				
Output				
Sensor supply	12- 24 V/DC; 50 mA; galvanically not insulated			
57/100 mm				
Relay output				
2 change over contacts				
Load	230 VAC/5 A – 30 VDC/2 A, with ohm resistive burden			
Switching cycles	0.5 * 10 ⁵ at max. contact rating			
	5 * 10 ⁶ mechanically			
Power supply				
Supply voltage	Multi voltage power supply unit 100-240 VAC nominal voltage			
	+/-10%, 50/60 Hz			
(galvanically insulated)	18-36 VDC			
Power consumption	max. 30 VA (57 mm, 100 mm)			
Memory	Parameter memory EEPROM			
Data life	>20 years			
Ambient conditions				
Working temperature	0...60 °C			
Storage temperature	-20...80 °C			
Climatic resistance	rel. \leq 75 % on year average without dew			
EMV	DIN 61326			
CE-sign	Conformity to 89/336/EWG			
Safety standard	DIN 61010			

Troubleshooting

10. Troubleshooting

The following list gives the recommended procedure for dealing with faults and locating their possible cause.

10.1. Questions and answers

- I. The unit permanently indicates overflow „----“.
 - The input has a very high measurement, check the measuring circuit.
- II. The unit permanently indicates underflow „_ _ _ _“.
 - The input has a very low measurement, check the measuring circuit.
- III. The device shows “HELP” in the 7-segment display.
 - The unit has found an error in the configuration memory. Perform a reset on the default values and reconfigure the unit according to your application.
- IV. Program numbers for parameterisation the input are not available.
 - The program lock is set to a user level that does not permit access.
- V. „Err1“ lights up in the 7-segment display.
 - This error can only be eliminated by the manufacturer.

10.2. Reset to default values

To return the unit to a defined basic state, a reset can be carried out to the default values.

The following procedure should be used:

- I. Switch off the power supply
- II. Press button [P]
- III. Switch on the power supply and press [P] for further approx. 2 seconds.

With reset, the default values of the program table are loaded and used for subsequent operation. This puts the unit back to the state in which it was supplied.

Caution! This is only possible when the programming lock PN50 allows access to all PNs or “HELP” is shown in the display.

Caution! All application-related data are lost.

