

Alternating voltage, alternating current

microprocessor based technology

- Free scalable display and setpoints from -999 up to +9999
- Standard: 2 setpoints, min/max memory - optional analogue output
- Mounting into panels with thickness up to 50 mm

72x36

8888

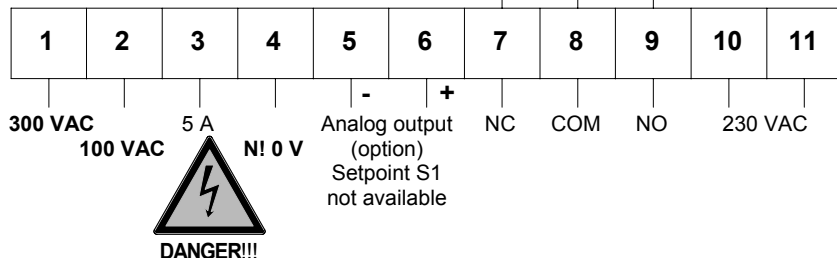
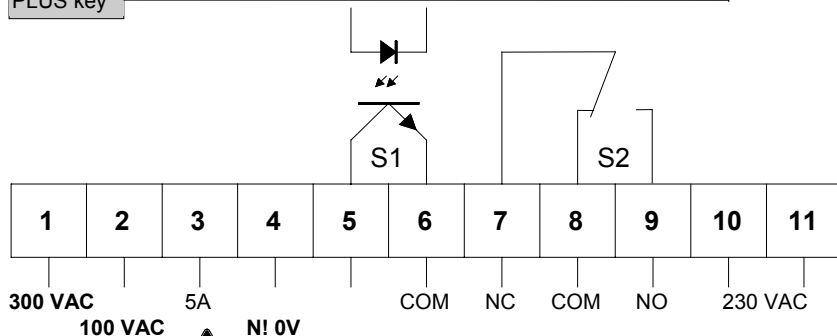
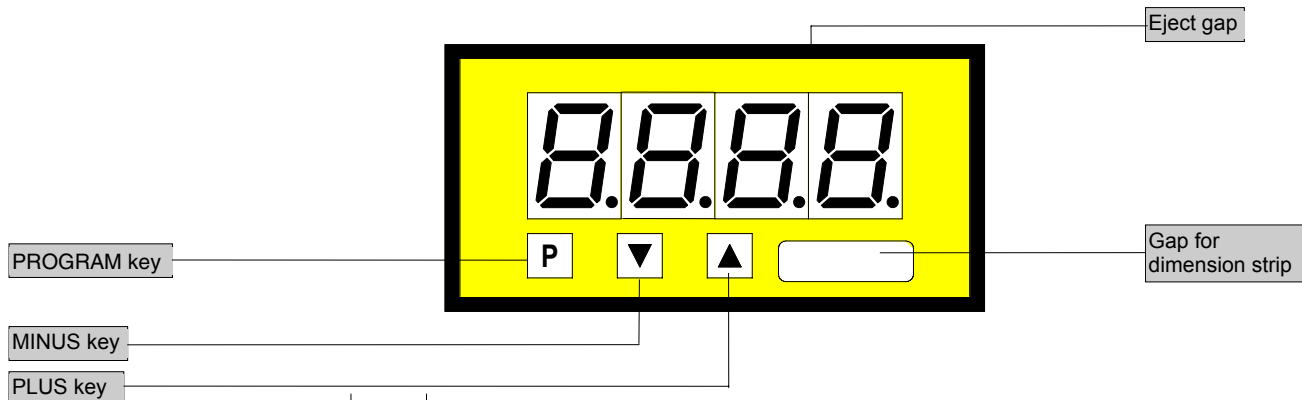

ORDER NUMBER OF TYPE

Standard
PVE 4.004.6522B

True effective value RMS
PVE 4.104.6522B

Power supply 115 VAC
(connection via terminal 10 and 11)

Standard
True effective value RMS

PVE 4.004.6422B
PVE 4.104.6422B

Power supply 24 VDC
- galv. insulated - (11=plus, 10= minus)

Standard
True effective value RMS

PVE 4.004.6722B
PVE 4.104.6722B

Caution!

With high input voltages 100 VAC/300 VAC, always connect terminal 4 (0V) to N-conductor. Change jumper only in voltage-free state and use an insulated screwdriver when adjusting the potentiometer.

Options

- LED green
- Protection: IP 54 at the front
- Protection: IP 65 at the front
- Plug in terminal with protection IP40
- Plug in terminal with protection IP54
- Plug in terminal with protection IP65
- Analog output 0-10 VDC (12 bit)
- Analog output 0-20 mA/load 500 Ω (12 bit)
- Analog output 4-20 mA/load 500 Ω (12 bit)
- Analog output 0-10 VDC (12 bit) (power supply 24 VDC galvanically insulated)
- Analog output 0-20 mA/load 500 Ω (12 bit) (power supply 24 VDC galvanically insulated)
- Analog output 4-20 mA/load 500 Ω (12 bit) (power supply 24 VDC galvanically insulated)

With analog output there is no setpoint S1!

- Dimension strip selectable (7 characters max.)
- Other power supplies on demand
- Measuring range 1 A on demand

Technical data

Dimensions	Housing	72 x 36 x 97 mm, including screw terminal
	Assembly cut out	68.0 ^{+0.7} x 33.0 ^{+0.6} mm
	Fastening	special quick plastic clamp proper to fix in wall thickness up to 50 mm
	Housing material	PC/ABS blend, colour black, UL94V-0
	Protective system	at the front IP40 connection IP00
	Weight	approx. 0.190 kg
	Connection	at the rear side via terminals up to 2.5 mm ²
Input	Measuring range	0-100 V, 300 V, 5 A - (optional 0-2 V, 20 V, 1 A) all ranges are selectable via connection terminal
	Input resistance	Ri with 100 V = 1 MΩ 2 V = 20 KΩ 300 V = 4 MΩ 20 V = 200 KΩ 1 A = 276 mΩ 5 A = 56 mΩ
Output	Relay output	charge 240 VAC/0.25 A – 24 VDC/1 A, with ohm resistive burden
	Switching cycles	2 * 10 ⁵ at max. contact rating 10 * 10 ⁶ mechanically
	Open collector Analogue output	supply by customers (U _B =5-40 V/I _{max} =100 mA) 0-10 VDC (12 bit) 0-20 mA (12 bit) - load 500 Ohm 4-20 mA (12 bit) - load 500 Ohm
		} The analogue output is galvanic insulated from the measuring input!
Accuracy	Resolution	-999 up to +9999
	Temp. drift	I~200 ppm/k – U~100 ppm/K
	Measuring principle	voltage frequency transformer
PVE 4.0x4.6xx2B	Frequency range	nominal precision 40 Hz up to 1000 Hz
	Measuring fault	voltage range: +/-0.5 % of measuring value, +/-0.07 % of final value 0 – 1 A range +/-0.5 % of measuring value, +/-0.07 % of final value 1 – 5 A range +/-1 % of measuring value, +/-0.07 % of final value
PVE 4.1x4.6xx2B	Measuring (input)	via rectifier - (effective value with sine waveform only)
	Measuring fault	voltage range: +/-0.5 % of measuring value, +/-0.07 % of final value, crestfactor 3 0 – 1 A range +/-0.5 % of measuring value, +/-0.07 % of final value, crestfactor 3 1 – 5 A range +/-1 % of measuring value, +/-0.07 % of final value, crestfactor 3
	Measuring (input)	True effective value RMS
Power unit	Supply voltage	230/115 VAC +/- 10 % (50-60 Hz), 24 VDC +/-10 % galvanic insulated
	Power consumption	approx. 3 VA
Indication	Display	LED with 7 segments, 14 mm high, red 4-digit = indication 9999
	Overflow	Indication of 4 transversal bars
	Indication time	from 0.1 up to 10.0 seconds adjustable
Ambient conditions	Working temperature	0 up to + 60 °C
	Storing temperature	-20 up to + 80 °C

Housing:

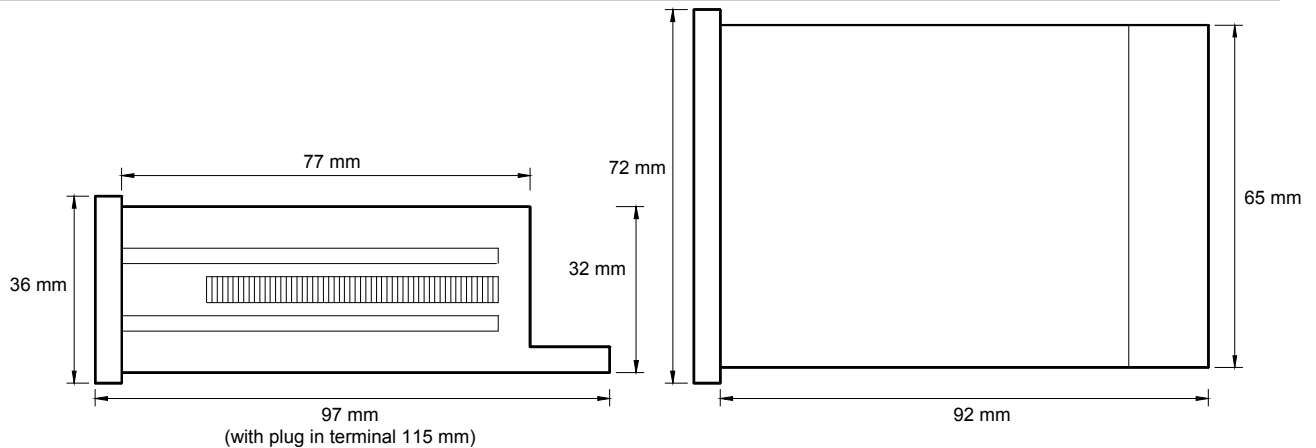

CE-sign

For unlimited use of the instrument within the directives for electromagnetic compatibility 89/336/EC analogue input wires have to be used with shielded cable and cable's shield connected to earth ground at one end only.

Wiring diagram, programming, instructions

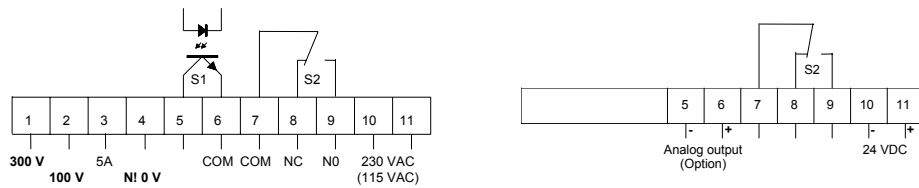

Setting

1. Connect the instrument according to the wiring diagram.
2. After power on, the instrument runs into a lamp test and returns back to the standard mode.
3. Connect the desired measuring value to the measuring input.
4. Pressing the **P**-key enters the program mode with indication of "P1" on the display.
5. Pressing the **P**-key and **▲**-key simultaneously steps through the different program numbers .
6. Pressing **▲** or **▼**-key shows the current values.
7. To change values use **▼**- or **▲**-key.
8. Memorizing of the values under program number 1 and 2 by pressing Plus- and **▼**-key simultaneously . Four transversal bars are indicating memorization.
9. Otherwise the remaining values will be memorized automatically 7 seconds after the last touch of key with leaving program mode.

Additional key-functions in standard mode for indication of min/max values.

Simultaneously pressing of **▼** and **▲** key deletes and actualizes min/max-memory.
▲ key enters max-memory.
▼ key enters min-memory.

Instructions

After power on the instrument with his inbuilt microcontroller starts with an initial program activating lamp test and readout of memorized parameters in an EEPROM. In case of loosing parameters or any defects in hardware the system generates an error message "HELP". This function prevents damage from peripherals and human life, totally reset is required. After a new power on, the system remains in lamp test while pressing **P**-key. Then the unit stores the default parameters and is ready for new programming.

The unit you have bought provides several different voltages and current inputs as well as optional analog output, relay contacts and open collector setpoints. In order to achieve the maximum value indication of 9999, the following minimum input voltages/currents are required at the various measuring inputs:

Measuring input	2 V	20 V	100 V	300 V	1 A	5 A
U/I min	1 V	10 V	50 V	200 V	0.4 A	2.5 A
U/I max	3 V	30 V	150 V	300 V	1 A	5 A

The following diagrams are showing the switching operation of PVE4 relay contacts and open collector outputs, the hysteresis is free programmable. There are two kinds of operation:

Example: operation current

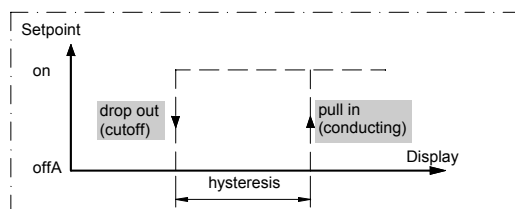

Example: quiescent current

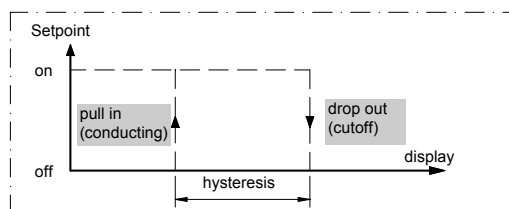

Operation current means that the open collector will be pulled in (conducting) if reaching the adjusted setpoint.

Quiescent current means that the open collector will be dropped out (cutoff) if reaching the adjusted setpoint.

Program table, example for programming

Subject to technical alteration – status 02/2006 - PVE446GB.DOC

Program table 1

Program-Number (PN)	Function	Remark	Display	Basic parameter after reset
1	Input of desired indication value	Feed measured magnitude (acknowledged by pressing key P and ▼) e.g. 100 V measuring input = final value 3500	-999 to +9999	2000
2	Input of offset for indication value	Feed measured magnitude (acknowledged by pressing key P and ▼) e.g. 0.1 A measuring input = initial value 0	-999 to +9999	0
3	Setting of decimal point	Press ▲ until desired decimal point is shown		no decimal. point
4	Input of display time	Display time = measuring time Method of measurement integrating	0.1 to 10.0 seconds	1.0
5	Input of final value for analog output	Option	-999 to +9999	2000
6	Input of offset for analog output	Option	-999 bis +9999	0

Program table 2 (setpoints)

S1 PN	S2 PN	Function	Display	Basic parameter after reset
61	66	Setpoint	-999 to +9999	500 / 1500
62	67	Hysteresis	0 to +9999	1
63	68	Quiescent current	0	0
		Operating current	1	-

Example for programming

Measuring input: 100 VAC
Measuring value: 0 - 80 VAC
Display: 0 V =0.0 80 V=300.0
Displ.refresh time: 2.0 seconds
Setpoints: S1 ==> 60.0 and quiescent current
 open collector conducting = 58.0 ==> hysteresis 2.0
 S2 ==> 150.0 and operation current
 relay drop out = 80.0 ==> hysteresis 70.0
Analog output: 0 V output ==> display 0.0 ==> measuring value 0 V
 (no setpoint S1) 10 V output ==> display 300.0 ==> measuring value 80 V

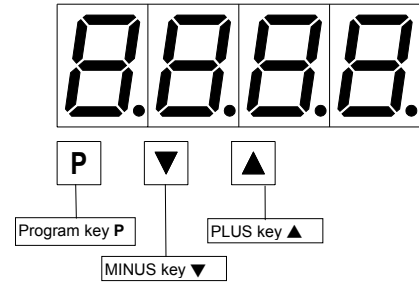

The basic adjustments concerning to the following program example are the ground parameters after a total reset occurring through a power on with pressing **P**-key (see previous page).

Program advices:

Pressing the **P**-key enters **always** the program mode with program number 1. The "P1" begins to blink in change with the current value after 3 seconds. After further 4 seconds the system leaves the program mode and goes to the standard mode. In program mode pressing **▼** or **▲** -key selects the current values which are free scalable with both the keys. In program number 1 and 2 the memorization will be executed by pressing **P** and **▼** simultaneously - 4 transversal bars indicate the storage. All the other parameters will be memorized automatically after leaving program mode.

Programming.

Switch power on!

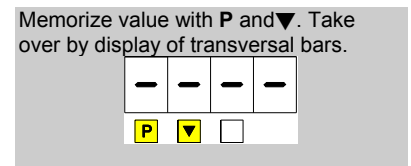
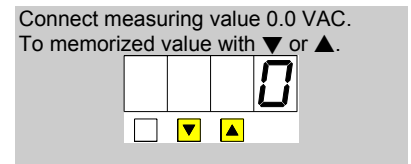
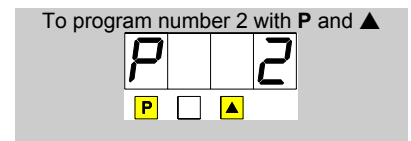
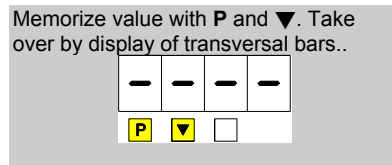
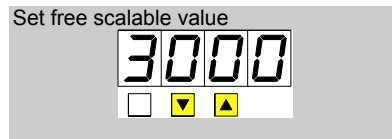
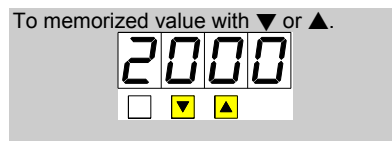
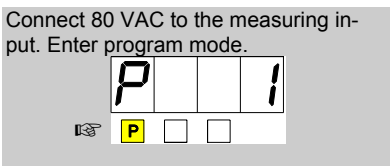
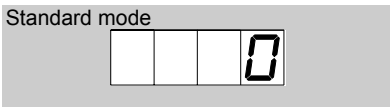

Example for programming

To program number 3 with P and ▲.

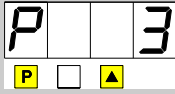

To memorized value with ▼ or ▲.

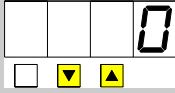

Set decimal point.

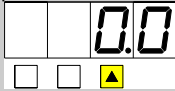

To program number 4 with P and ▲.

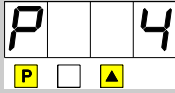

To memorized value with ▼ or ▲.

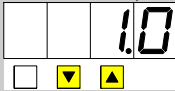

Set display time.

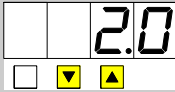

The following programming steps are necessary for the setpoint programming of S1 and S2 only.

To program number 61 with P and ▲.

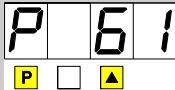

To memorized value with ▼ or ▲.



Set free scalable value for setpoint S1.



To program number 62 with P and ▲.



To memorized value with ▼ or ▲.



Set hysteresis for S1.



To program number 63 with P and ▲.



To memorized value with ▼ or ▲.

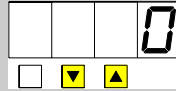

To program number 66 with P and ▲.

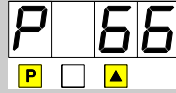

To memorized value with ▼ or ▲.



Set free scalable value for setpoint S2.



To program number 67 with P and ▲.

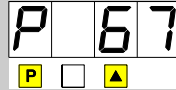

To memorized value with ▼ or ▲.



Set hysteresis for S2.



To program number 68 with P and ▲.



To memorized value with ▼ or ▲.

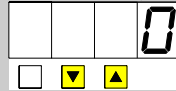

Set operation current.

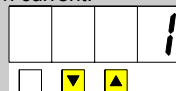

Programming finished.

All programmed values are memorized after 7 seconds. Jumps back into standard mode automatically.

The program numbers 5 and 6 are available with option analogue output only.

To program number 5 with P and ▲.

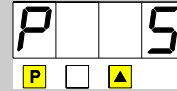

To memorized value with ▼ or ▲.



Set free scalable final indication value for analogue output.



To program number 6 with P and ▲.



To memorized value with ▼ or ▲.

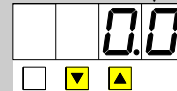

Programming finished.

All programmed values are memorized after 7 seconds. Jumps back into standard mode automatically.

Setting possibilities of the jumper field on the rear side.

